

MONITOUCH

V8

series



Expanding the Possibilities of the Future

Hakko Electronics Co., Ltd.
www.monitouch.com

MONITOUCH V8_{series}

For optimal performance, connectivity and usability
The MONITOUCH V8 series has expanded the potential of
programmable operator interface panels.

Realize the Ideal



High Performance

The new MONITOUCH series has realized the best possible performance with a newly developed high-speed algorithm and a high level of visibility for efficient operation.

Connectivity

8-way communication with up to eight kinds of devices and two USB channels ensure high compatibility and expandability of your system.

Usability

User-friendly component parts and functional switches enable simple and speedy display configuration.



- 65,536 colors
- Analog switches
- Compatible with 8-way communication
- Equipped with two USB channels (master/slave)
- Multi-output memory
- Pop-up window
- Alarm enhancement
- Multi-link 2 Ethernet function
- Configuration software V-SFT
- Component parts
- Ethernet expansion
- MES interface
- Specifications
- Dimensions and part names
- System configuration
- Option
- Option list
- Customer service
- Product warranty
- 30 fps video display in 16 million colors
- ON delay/ OFF delay
- Conditional visibility
- Flash ROM 12.5MB/ SRAM 512KB
- Operation log
- P12
- P13
- P14
- P16
- P18
- P19
- P20
- P21
- P22
- P24
- P26
- P28
- P29
- P32
- P34
- P36
- P37
- P38
- P39

Our wide range of products allows you to select

		15.0 inches	12.1 inches	10.4
<p>NEW</p> <h1>V8</h1> <p>series</p> <p>Revolutionary features for production sites: 8-way communication and 16-million colors high-resolution video display. As well as V8 series have the same panel cutouts as V7 series, the V7 screen program can be utilized in V8 series. A multi-feature model with the ultimate operator interface panel.</p>	High-performance model	<p>V815iX</p>  <p>TFT XGA 64K Color</p>	<p>V812iS/V812S</p>  <p>TFT SVGA 64K Color</p>	<p>V810iS/V810S</p>  <p>TFT SVGA 64K Color</p>
	Standard model			
<h1>V7</h1> <p>series</p> <p>Comes in a variety of models including large-size (15-inch XGA) and small-size (5.7-inch). A versatile and high-ranking series that can be widely used ranging from the net working to stand-alone.</p>	High-performance model	<p>V715X</p>  <p>TFT XGA 32K Color</p>	<p>V712iS/V712S</p>  <p>TFT SVGA 32K Color</p>	<p>V710iS/V710S</p>  <p>TFT SVGA 32K Color</p>
	Standard model			
<h1>V6</h1> <p>series</p> <p>Has all of the basic functions. Entry-level models that will satisfy your needs in superior usability and cost-effectiveness.</p>	Standard model			

Select the one that best fits your needs.

TFT Display device

SVGA Display resolution

64K Color Display color

inches	8.4 inches	7.7 inches	5.7 inches		
<p>V810iT/V810T</p>  <p>TFT VGA 64K Color</p>	<p>V808iSD/V808SD</p>  <p>TFT SVGA 64K Color</p>				
<p>V810iC/V810C</p>  <p>TFT VGA 64K Color</p>	<p>V808iCD/V808CD</p>  <p>TFT VGA 64K Color</p>	<p>V808iCH/V808CH</p>  <p>TFT VGA 64K Color</p>	<p>V806iTD/V806TD</p>  <p>TFT QVGA 64K Color</p>	<p>V806iCD/V806CD</p>  <p>STN QVGA 64K Color</p>	<p>V806iMD/V806MD</p>  <p>STN QVGA MONO</p>
<p>V710iT/V710T</p>  <p>TFT VGA 32K Color</p>	<p>V708iSD/V708SD</p>  <p>TFT SVGA 32K Color</p>				
<p>V710C</p>  <p>TFT VGA 128 Color</p>		<p>V708CD</p>  <p>STN VGA 128 Color</p>	<p>V706TD</p>  <p>TFT QVGA 32K Color</p>	<p>V706CD</p>  <p>STN QVGA 32K Color</p>	<p>V706MD</p>  <p>STN QVGA MONO</p>
		<p>V608CH</p>  <p>STN VGA 128 Color</p>	<p>V606eC</p>  <p>STN QVGA 16 Color</p>	<p>V606eM</p>  <p>STN QVGA MONO</p>	

V815 series

All information at the production site is displayed on the XGA wide screen! Flagship model in V8 series.

15-inch model



Flagship model XGA 65,536 colors

X



V815iX

V815 models

V815iXD

V815iX — [Power supply specifications] N/A: AC100-240V specifications D: DC24V (CE/UL/cUL approved)

Communication units

- OPCN-1
- T-Link
- CC-Link
- Ethernet
- PROFIBUS-DP
- DeviceNet *1
- FL-net
- SX Bus



Optional units

- Video input + RGB input
- RGB input (2ch)
- Video input + sound output
- RGB input + sound output
- RGB output + sound output
- Sound output

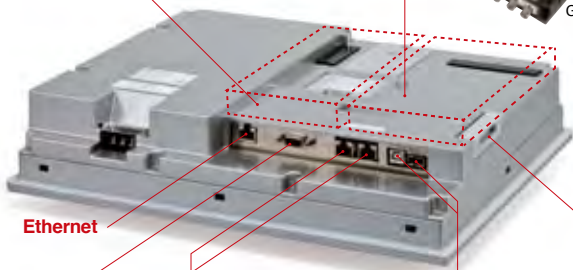
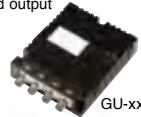

Ethernet

USB-A
USB-B ▶ P16

Serial connection

- D-Sub 9-pin ▶ P14
- PLC
 - Temperature controller/ Inverter
 - General PC
 - Bar code reader

Serial connection

- Modular 8-pin ▶ P14
- PLC
 - Temperature controller/ Inverter
 - Card recorder (CREC)
 - Bar code reader
 - V-I/O

- V-Link
- PLC ladder transfer
- Modbus slave
- Printer (serial)



	Model	V815iX
Basic specification	Display size	15 inches
	Display device	TFT color LCD
	Resolution	1,024×768 dots
	Display colors	65,536 colors(without blinks)/32,768 colors(with blinks)
	Display memory	FROM (12.5MB)
	Backup memory	SRAM (512KB)
Interface	D-Sub 9-pin CN1	RS-232C, RS-422/485, Asynchronous Data length: 7 bits, 8 bits, Parity: even, odd, none Stop bit: 1 bit, 2 bits Baud rate: 4800, 9600, 19200, 38400, 57600, 76800, 115200, 187500 ² bps
	Modular 8-pin MJ1/MJ2	RS-232C • RS-422/485(2-wire), Asynchronous Data length: 7 bits, 8 bits Parity: even, odd, none Stop bit: 1 bit, 2 bits Baud rate: 4800, 9600, 19200, 38400, 57600, 76800, 115200bps
	Ethernet	100BASE-TX /10BASE-T Built-in
	Communication I/F	Equipped
	Extend I/F	Equipped
	CF card I/F	Equipped
	USB I/F	Type A and B(Ver1.1)
Options	Video (4ch)	GU-00
	RGB input	GU-01
	RGB output	GU-02
	Video (2ch)+RGB input	GU-10
	RGB input (2ch)	GU-11
	Sound output	GU-00 ~ 03
Compatibility	Communication unit	CU-00 ~ 08
	I/O unit	V-I/O
	CE Marking ^{*3}	EN61000-6-2, EN61000-6-4
	UL/cUL ^{*3}	UL508
	RoHS directive	Complied

*1 Under development
*2 When connected with SIEMENS MPI
*3 Only with 24V DC models

Legend of icons



V812 series

High visibility and stability of SVGA.
Offers you high performance.

12.1-inch model 

High-performance model SVGA 65,536 colors

S



12.1 inches TFT SVGA 64K color 12.5M FROM 512K SRAM 3ch serial COM I/F CF A-B USB



With Ethernet port

V812iS    

Without Ethernet port

V812S 

V812 models

V812   [Power supply specifications] N/A: AC100-240V specifications D: DC24V (CE/UL/cUL approved)
[Touch switch specifications] N/A: Analog resistive switch M: Matrix resistive switch
[Functional specifications] N/A: Without built-in LAN port, without optional unit port
i: With built-in LAN port, with optional unit port

Communication units

- OPCN-1
- T-Link
- CC-Link
- Ethernet
- PROFIBUS-DP
- DeviceNet *1
- FL-net
- SX Bus



Optional units

- Video input + RGB input
- RGB input (2ch)
- Video input + sound output
- RGB input + sound output
- RGB output + sound output
- Sound output



Serial connection

- Modular 8-pin  P14
- PLC
 - Temperature controller/ Inverter
 - Card recorder (CREC)
 - Bar code reader
 - V-I/O
 - V-Link
 - Touch switch
 - PLC ladder transfer
 - Modbus slave
 - Printer (serial)

Ethernet

- Serial connection D-Sub 9-pin  P14
- PLC
 - Temperature controller/ Inverter
 - General PC
 - Bar code reader



	Model	V812iS	V812S
Basic specification	Display size	12.1 inches	
	Display device	TFT color LCD	
	Resolution	800x600 dots	
	Display colors	65,536 colors(without blinks)/32,768 colors(with blinks)	
Interface	D-Sub 9-pin CN1	RS-232C, RS-422/485, Asynchronous Data length: 7 bits, 8 bits, Parity: even, odd, none Stop bit: 1 bit, 2 bits Baud rate: 4800, 9600, 19200, 38400, 57600, 76800, 115200, 187500 ² bps	
	Modular 8-pin MJ1/MJ2	RS-232C • RS-422/485(2-wire), Asynchronous Data length: 7 bits, 8 bits Parity: even, odd, none Stop bit: 1 bit, 2 bits Baud rate: 4800, 9600, 19200, 38400, 57600, 76800, 115200bps	
Options	Ethernet	100BASE-TX /10BASE-T Built-in	Option (CU-03-3)
	Communication I/F	Equipped	
	Extend I/F	Equipped	-
	CF card I/F	Equipped	
Compatibility	USB I/F	Type A and B(Ver1.1)	
	Video (4ch)	GU-00	-
	RGB input	GU-01	-
	RGB output	GU-02	-
	Video (2ch)+RGB input	GU-10	-
Option List	RGB input (2ch)	GU-11	-
	Sound output	GU-00 ~ 03	-
	Communication unit	CU-00 ~ 08	
	I/O unit	V-I/O	
Customer Service	CE Marking ³	EN61000-6-2, EN61000-6-4	
	UL/cUL ³	UL508/UL1604 ⁴	
	RoHS directive	Complied	

*1 Under development *2 When connected with SIEMENS MPI
*3 Only with 24V DC models
*4 Contact us if UL1604 needs to be supported.

Products
Display/Operation Features
Communication Features
Expandability
Usability
Configuration Software (V-SFT)
Component Parts
Expandability with MMS/Ethernet
Specifications
Dimensions and Part Names
System Configuration
Option
Option List
Customer Service
Product Warranty

V810 series

High-performance panels in 65,536 colors
Three grades of models from standard to high-performance

10.4-inch model *5

High-performance model SVGA

Highly-functional model VGA

Standard model VGA

S



T



C



10.4 inches TFT SVGA 64K color 12.5μ FROM 512K SRAM 3ch serial COM I/F CE A+B USB

With Ethernet port
V810iS

Without Ethernet port
V810S

10.4 inches TFT VGA 64K color 12.5μ FROM 512K SRAM 3ch serial COM I/F CE A+B USB

With Ethernet port
V810iT

Without Ethernet port
V810T

10.4 inches TFT VGA 64K color 12.5μ FROM 512K SRAM 3ch serial COM I/F CE A+B USB

With Ethernet port
V810iC

Without Ethernet port
V810C^{*1}

V810 models

V810 [Power supply specifications] N/A: AC100-240V specifications D: DC24V (CE/UL/cUL approved)
[Touch switch specifications] N/A: Analog resistive switch M: Matrix resistive switch
[Device specifications] S: TFT color LCD (SVGA) T: TFT color LCD (VGA) C: TFT color LCD (VGA)
[Functional specifications] N/A: Without built-in LAN port, without optional unit port
i: With built-in LAN port, with optional unit port *2

*1 FROM 4.5Mbytes · SRAM 128Kbytes
*2 Optional ports are not available in V810iC

Communication units

- OPCN-1
- T-Link
- CC-Link
- Ethernet
- PROFIBUS-DP
- DeviceNet *3
- FL-net
- SX Bus



Optional units

- Video input + RGB input
- RGB input (2ch)
- Video input + sound output
- RGB input + sound output
- RGB output + sound output
- Sound output

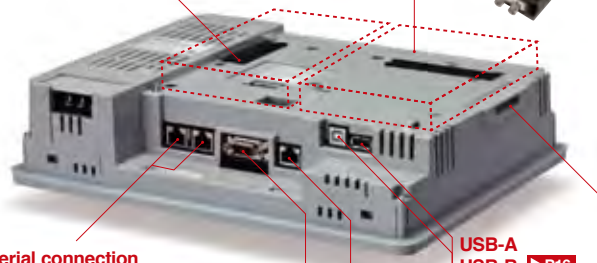

Serial connection

Modular 8-pin

- PLC
- Temperature controller/ Inverter
- Card recorder (CREC)
- Bar code reader
- V-I/O
- V-Link
- Touch switch
- PLC ladder transfer
- Modbus slave
- Printer (serial)

Ethernet

Serial connection

D-Sub 9-pin

- PLC
- Temperature controller/ Inverter
- General PC
- Bar code reader

CF Card



	Model	V810iS	V810S	V810iT	V810T	V810iC	V810C
Basic specification	Display size	10.4 inches					
	Display device	TFT color LCD					
	Resolution	800×600 dots			640×480 dots		
	Display colors	65,536 colors(without blinks)/32,768 colors(with blinks)					
Display memory		FROM (12.5MB)					FROM (4.5MB)
	Backup memory	SRAM (512KB)					SRAM (128MB)
Interface	D-Sub 9-pin CN1	RS-232C, RS-422/485, Asynchronous Data length: 7 bits, 8 bits, Parity: even, odd, none Stop bit: 1 bit, 2 bits, Baud rate: 4800, 9600, 19200, 38400, 57600, 76800, 115200, 187500*4bps					
	Modular 8-pin MJ1/MJ2	RS-232C · RS-422/485(2-wire), Asynchronous Data length: 7 bits, 8 bits Parity: even, odd, none Stop bit: 1 bit, 2 bits, Baud rate: 4800, 9600, 19200, 38400, 57600, 76800, 115200bps					
	Ethernet	100BASE-TX /10BASE-T Built-in	Option (CU-03-3)	100BASE-TX /10BASE-T Built-in	Option (CU-03-3)	100BASE-TX /10BASE-T Built-in	Option (CU-03-3)
	Communication I/F	Equipped					
Options	Extend I/F	Equipped	-	Equipped	-	-	-
	CF card I/F	Equipped					
	USB I/F	Type A and B(Ver1.1)					
	Video (4ch)	GU-00	-	GU-00	-	-	-
RGB input	GU-01	-	GU-01	-	-	-	
RGB output	GU-02	-	GU-02	-	-	-	
Video (2ch)+RGB input	GU-10	-	GU-10	-	-	-	
RGB input (2ch)	GU-11	-	GU-11	-	-	-	
Sound output	GU-00 ~ 03	-	GU-00 ~ 03	-	-	-	
Communication unit I/O unit	CU-00 ~ 08 V-I/O						
Compatibility	CE Marking ^{*5}	EN61000-6-2, EN61000-6-4					
	UL/cUL ^{*5}	UL508/UL1604 ^{*6}					
	RoHS directive	Complied					

*3 Under development *4 When connected with SIEMENS MPI

*5 Only with 24V DC models

*6 Contact us if UL1604 needs to be supported.

Legend of icons

Display size (inches)

Display device

Display resolution

Display colors

FROM capacity



SRAM (byte)

Serial port

Ethernet 100BASE-TX/10BASE-T

V808 series

Compact yet functional panels in 65,536 colors. SVGA models are also available.

8.4-inch model  

High-performance model SVGA

Standard model VGA



With Ethernet port

V808iSD    

Without Ethernet port

V808SD 

With Ethernet port

V808iCD 

Without Ethernet port

V808CD^{*1} 

V808 models

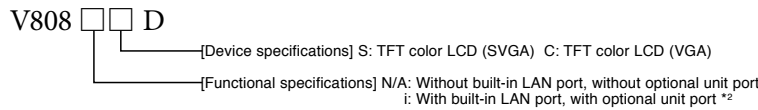

^{*1} FROM 4.5Mbytes • SRAM 128Kbytes
^{*2} Optional ports are not available in V808iC

Communication units

- OPCN-1
- T-Link
- CC-Link
- Ethernet
- PROFIBUS-DP
- DeviceNet *3
- FL-net
- SX Bus



Optional units

- Video input + RGB input
- RGB input (2ch)
- Video input + sound output
- RGB input + sound output
- RGB output + sound output
- Sound output

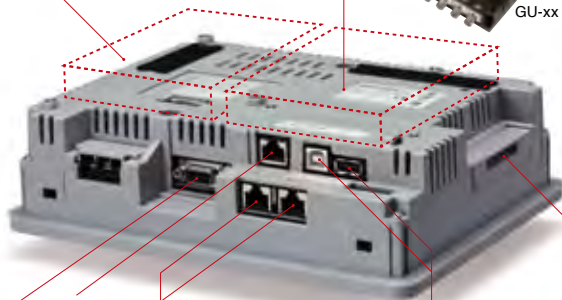
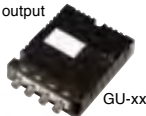

Ethernet

Serial connection

- D-sub 9-pin 
- PLC
 - Temperature controller/ Inverter
 - General PC
 - Bar code reader

Serial connection

- Modular 8-pin 
- PLC
 - Temperature controller/ Inverter
 - Card recorder (CREC)
 - Bar code reader
 - V-I/O
 - V-Link
 - Touch switch
 - PLC ladder transfer
 - Modbus slave
 - Printer (serial)

USB-A USB-B

CF Card



	Model	V808iSD	V808SD	V808iCD	V808CD
Basic specification	Display size	8.4 inches			
	Display device	TFT color LCD			
	Resolution	800×600 dots		640×480 dots	
	Display colors	65,536 colors(without blinks)/32,768 colors(with blinks)			
	Display memory	FROM (12.5MB)		FROM (4.5MB)	
	Backup memory	SRAM (512KB)		SRAM (128MB)	
Interface	D-Sub 9-pin CN1	RS-232C, RS-422/485, Asynchronous Data length: 7 bits, 8 bits, Parity: even, odd, none Stop bit: 1 bit, 2 bits Baud rate: 4800, 9600, 19200, 38400, 57600, 76800, 115200, 187500 ⁴ bps			
	Modular 8-pin MU1/MJ2	RS-232C • RS-422/485(2-wire), Asynchronous Data length: 7 bits, 8 bits Parity: even, odd, none Stop bit: 1 bit, 2 bits Baud rate: 4800, 9600, 19200, 38400, 57600, 76800, 115200bps			
	Ethernet	100BASE-TX /10BASE-T Built-in	Option (CU-03-3)	100BASE-TX /10BASE-T Built-in	Option (CU-03-3)
	Communication I/F	Equipped			
Options	Extend I/F	Equipped	-	-	-
	CF card I/F	Equipped			
	USB I/F	Type A and B(Ver1.1)			
	Video (4ch)	GU-00	-	-	-
	RGB input	GU-01	-	-	-
RGB output	GU-02	-	-	-	
Video (2ch)+RGB input	GU-10	-	-	-	
RGB input (2ch)	GU-11	-	-	-	
Sound output	GU-00 ~ 03	-	-	-	
Communication unit	CU-00 ~ 08				
I/O unit	V-I/O				
Compatibility	CE Marking	EN61000-6-2, EN61000-6-4			
	UL/cUL	UL508/UL1604 ^{*5}			
	RoHS directive	Complied			

^{*3} Under development ^{*4} When connected with SIEMENS MPI
^{*5} Contact us if UL1604 needs to be supported.

Products
Display/Operation Features
Communication Features
Expandability
Usability
Configuration Software (V-SFT)
Component Parts
Expandability with MES/Ethernet
Specifications
Dimensions and Part Names
System Configuration
Option
Option List
Customer Service
Product Warranty

V806 series

High-performance compact models

5.7-inch model

Standard model QVGA 65,536 colors

Standard model QVGA (16 grayscale)

T



C



M

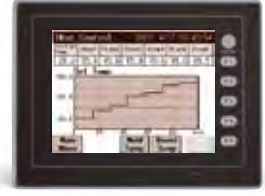

5.7 inches TFT QVGA 64K color 4.5M FROM 512K SRAM 2ch serial COM I/F A+B USB DC power Analog

5.7 inches STN QVGA 64K color 4.5M FROM 512K SRAM 2ch serial COM I/F A+B USB DC power Analog

5.7 inches STN QVGA MONO 4.5M FROM 512K SRAM 2ch serial COM I/F A+B USB DC power Analog

With Ethernet port
V806iTD
Without Ethernet port
V806TD¹ ²

With Ethernet port
V806iCD
Without Ethernet port
V806CD¹ ²

With Ethernet port
V806iMD
Without Ethernet port
V806MD¹ ²

V806 models

V806 D

[Device specifications] T: TFT color LCD (QVGA) C: STN color LCD (QVGA) M: STN monochrome LCD (QVGA)

[Functional specifications] N/A: Without built-in LAN port i: With built-in LAN port

¹ SRAM 128Kbytes
² Concurrent use of Ethernet and CF card is not available

Communication units

- OPCN-1
- T-Link
- CC-Link
- Ethernet
- PROFIBUS-DP
- DeviceNet *3
- FL-net
- SX Bus



Optional units

- D-Sub 9-pin + CF Card I/F

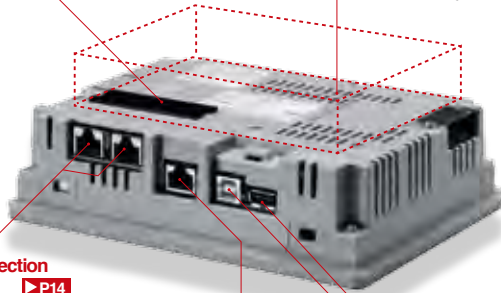

Serial connection

- Modular 8-pin **P14**
- PLC
 - Temperature controller/ Inverter
 - Card recorder (CREC)
 - V-Link
 - PLC ladder transfer
 - Modbus slave
 - Printer (serial)
 - V-I/O

USB-A
USB-B **P16**

Ethernet

	Model	V806iTD	V806TD	V806iCD	V806CD	V806iMD	V806MD
Basic specification	Display size	5.7 inches					
	Display device	TFT color LCD		STN color LCD		STN monochrome LCD	
	Resolution	320x240 dots					
	Display colors	65,536 colors(without blinks) 32,768 colors(with blinks)				16 grayscale (with blinks)	
Display memory	FROM (4.5MB)						
	Backup memory	SRAM (512KB)	SRAM (128KB)	SRAM (512KB)	SRAM (128KB)	SRAM (512KB)	SRAM (128KB)
Interface	D-Sub 9-pin CN1 ⁴	RS-232C · RS-422/485 (2-wire), Asynchronous Data length: 7 bits, 8 bits Parity: even, odd, none Stop bit: 1 bit, 2 bits Baud rate: 4800, 9600, 19200, 38400, 57600, 76800, 115200bps					
	Modular 8-pin MJ1/MJ2 ⁵	RS-232C, RS-422/485, Asynchronous Data length: 7 bits, 8 bits, Parity: even, odd, none Stop bit: 1 bit, 2 bits Baud rate: 4800, 9600, 19200, 38400, 57600, 76800, 115200, 187500 ⁶ bps					
Options	Ethernet	100BASE-TX /10BASE-T Built-in	Option (CU-03-3)	100BASE-TX /10BASE-T Built-in	Option (CU-03-3)	100BASE-TX /10BASE-T Built-in	Option (CU-03-3)
	Communication I/F	Equipped					
	CF card I/F	Equipped ⁴					
Options	USB I/F	Type A and B (Ver1.1)					
	Communication unit	CU-00 ~ 08					
Compatibility	I/O unit	V-I/O					
	CE Marking	EN61000-6-2, EN61000-6-4					
	UL/cUL	UL508/UL1604					
	RoHS directive	Complied					



³ Under development
⁴ Available only when equipped with DU-10 (option)
⁵ MJ2 is connectable with RS-422 (4-wire)
⁶ Available only when connected with SIEMENS MPI (MJ2 only). Not compatible with D-Sub 9-pin (option)

Legend of icons

Display size (inches)
 Display device
 Display resolution
 Display colors
 FROM capacity
 SRAM (byte)
 Serial port
 Ethernet 100BASE-TX/10BASE-T

V808CH series

Pendant type model in V8 series

7.5-inch model  

Handy type model supporting Ethernet



7.5 inches TFT VGA 64K color 2ch serial CF B USB DC power Analog

With Ethernet port
V808iCH   

Without Ethernet port
V808CH  

V808CH models
V808 CH

	Key switch	Deadman switch	
		Switch type	External output
0	Unequipped	Momentary	Unequipped
1	Equipped	Momentary	Unequipped
2	Unequipped	3-position	1 contact
3	Equipped	3-position	1 contact
4	Unequipped	3-position	2 contacts

[Functional specifications]
N/A: Without built-in LAN port i: With built-in LAN port



CF Card I/F

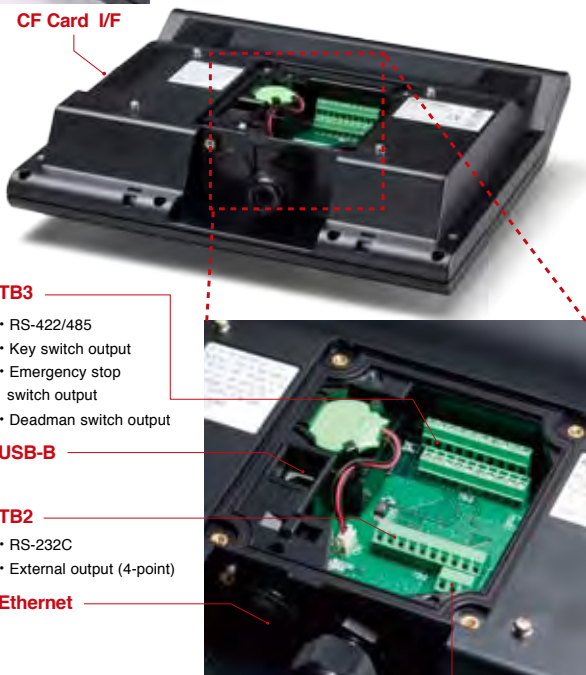

TB3

- RS-422/485
- Key switch output
- Emergency stop switch output
- Deadman switch output

USB-B

TB2

- RS-232C
- External output (4-point)

Ethernet

TB1
power supply
(DC24V)

	Model	V808iCHx	V808CHx
	Display size	7.5 inches	
	Display device	TFT color LCD	
	Resolution	640x480 dots	
	Display colors	65,536 colors(without blinks) / 32,768 colors(with blinks)	
	Display memory	FROM (12.5MB)	FROM (4.5MB)
	Backup memory	SRAM (512KB)	SRAM (128KB)
	Clock	Equipped	
	Ethernet	100BASE-TX /10BASE-T Built-in	Unequipped
	CF card I/F	Equipped	
	USB I/F	Type B (Ver1.1)	
Function switch specifications	Number of function switches	12 switches (4: External output)	
	Switch type	Membrane switch	
	Mechanical life	1 million times or more	
Emergency stop switch specifications	Switch type	Push lock type (b-contact point, 2 circuits)	
	Mechanical life	More than 100,000 times	
	Rated voltage	DC24V	
	Rated current	1A (load resistance)	
Key switch specifications	Contact point	a-contact point, 1 circuit	
	Mechanical life	More than 250,000 times	
	Electrical life	More than 100,000 times (switching frequency 1,200 times/h)	
Deadman switch specifications	3-position	Switch type	3-position output (a-contact point, 2 circuit ^{*1})
		Mechanical life	Off → On 1 million times or more Off → On → Off (direct open-circuit) more than 100,000 times
		Rated voltage	DC24V
	Rated current	1A (load resistance)	
Momentary	Switch type	Momentary	
	Mechanical life	1 million times or more	
External I/F	TB2	RS-232C, Asynchronous Data length: 7 bits, 8 bits Parity: even, odd, none Stop bit: 1 bit, 2 bits, Baud rate: 4800, 9600, 19200, 38400, 76800, 115200bps	
	TB3	RS-422/485, Asynchronous Data length: 7 bits, 8 bits, Parity: even, odd, none Stop bit: 1 bit, 2 bits, Baud rate: 4800, 9600, 19200, 38400, 76800, 115200, 187500 ² bps	
Compatibility	CE Marking	EN61000-6-2, EN61000-6-4	
	UL/cUL	UL508	
	RoHS directive	Complied	

*1 a-contact point and 2 circuits are available only in V808(i)CH4. Only one circuit is available in V808(i)CH2 and V808(i)CH3.

*2 When connected with SIEMENS MPI

Products
Display/Operation Features
Communication Features
Expandability
Usability
Configuration Software (V-SFT)
Component Parts
Expandability with MES/Ethernet
Specifications
Dimensions and Part Names
System Configuration
Option
Option List
Customer Service
Product Warranty

Display Features

Improved visibility for operator interface panels

Great power of the visibility facilitates the operation by high-resolution and high-speed video display.

High-resolution Display

The image shown below is not an actual display image.

65,536 colors*1
(32,768 colors with blinks)

High-resolution display of 65,536 colors without blinks and 32,768 colors with blinks enables clear display of JPG and BMP images. Realistic appearance of photos, illustrations and 3D parts improves visibility and makes it easy for operators to quickly grasp the conditions.



*1 Except V806iMD/V806MD

High-level images are displayed in real time without missing any information

Display of 30 fps video images in 16 million colors*2

First in Industry

High-speed displaying of 30 frames per second is possible. Even displays for production of a short tact time can be made without any delay.

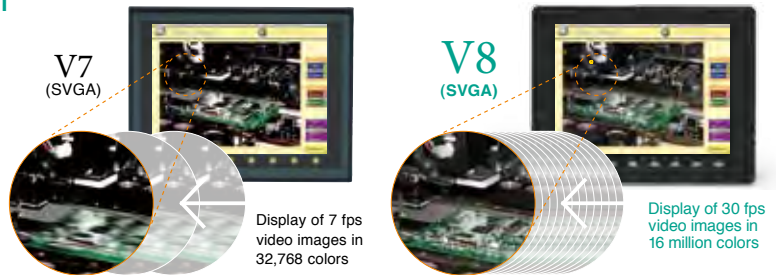

Display of 7 fps video images in 32,768 colors

Display of 30 fps video images in 16 million colors

Monochrome display with 256 gradations*2

Monochrome images that are often used by image processor can be displayed more clearly. The reproduction capacity for gradation and pattern-indented surfaces has been drastically improved.



Detailed shaded drawings are displayed clearly.

Can be utilized to monitor a production line running at high speed.

*2 For V808iS, 260,000-color displays and 64-gradation monochrome displays are possible.

Clear and smooth letters

The stroke font can be displayed to appear smooth even for magnified characters.

The stroke font is defined by lines. Since it does not depend on the resolution of the device, which is different from the bitmap font, fonts can be magnified or shrunk freely. Unicode enables you to edit the project in various languages.

Language		Japanese	English/European	Traditional Chinese	Simplified Chinese	Korean	Central European	Cyrillic	Greek	Turkish	Unicode(UTF-8)
Bitmap font	Non-gothic	● Japanese/Japanese32	●	●	●	●	●	●	●	●	●
	Gothic	● Gothic/Gothic (IBM extension)	● Gothic (Mincho)	×	×	×	×	×	×	×	×
Stroke font		●	●	●	●	●	●	●	●	●	●



Operation Features

"User-oriented operability" by high-speed and smooth display

High-speed accelerator and algorithm ensure stress-free operation.

Free switch layout with analog resistive switches

Analog resistive switch

Analog resistive switches are used for MONITOUCH. Freer switch layout facilitates screen designing while more intensive operation display can be produced.

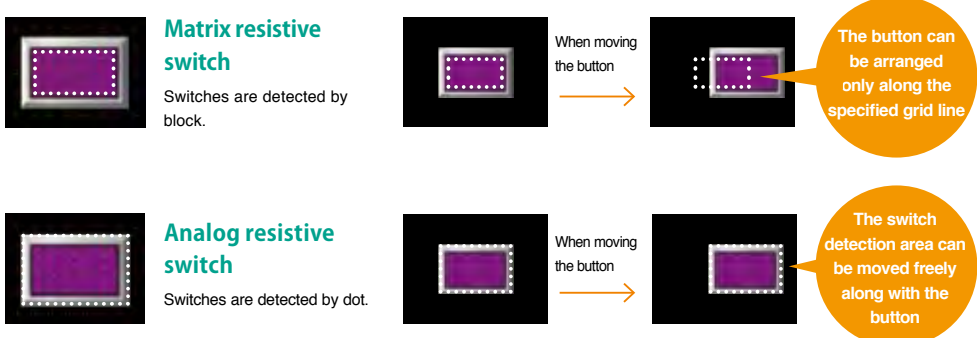

*The area outside the dotted lines is not detected.

Slider switch

Slider switches enable data entry without inputting data using the numeral key pad. Values can be modified easily and quickly, even for a fine adjustment.

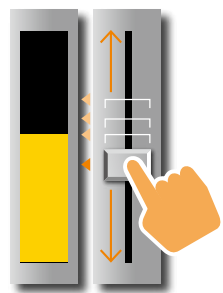

Scroll bar

Messages and JPEG files out of the display area can be seen by scrolling the area.

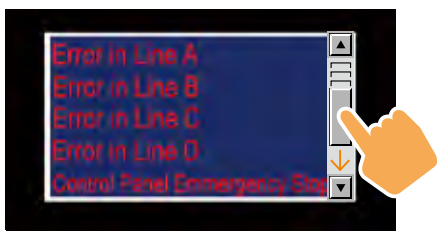

*Scrolling direction varies depending on functions

Memo pad function

Analog resistive switches allow you to use MONITOUCH as a memo pad for hand writing. You can draw a picture or write a message on the display for use as a message board at production sites.



High-speed accelerator and algorithm ensure speedy, high-quality displays as well as higher usability in panel operation.

V8 series has drastically improved the processing capacity for drawing, calculation and communication in terms of smooth drawing and quick response.

Speedy drawing
V8 is equipped with a high-speed graphic accelerator, which improves speed for drawing graphics and characters.

High-speed communication
High-speed communication with PLCs is possible. By improving communication efficiency, the cycle speed can be shortened even when linked with more than two PLCs.

Quick response
Switch response speed has been shortened by efficient data processing and task assignment.

Products
Display/Operation Features
Communication Features
Expandability
Usability
Configuration Software (V-SFT)
Component Parts
Expandability with MES/Ethernet
Specifications
Dimensions and Part Names
System Configuration
Option
Option List
Customer Service
Product Warranty

Communication Features

Multi-communication using the gateway function

Is capable of the connection with up to eight devices by combining Ethernet and serial communication. More advanced and expanded network can be now realized.

Connectable with up to eight different kinds of devices and different manufacturers' PLCs

8-way communication

A combination of Ethernet (eight protocols) and serial communication (three protocols) allows the 8-way communication, which enables connection among a V8 and up to eight kinds of devices consisting of PLCs and peripherals of different manufacturers.

- Simultaneous communication and data transfer with eight kinds of devices
- Simultaneous monitoring and operation of multiple PLCs and peripherals
- Linkage between a V8 and various devices on the LAN network using the gateway function

Network Examples

Example 1 Serial connection (three ports)

Making a network linked with various automation devices

PLCs and peripherals of up to three kinds of units can be connected by serial connection. Even though two or more types of temperature controllers and inverters are used, they can be connected with one V8.

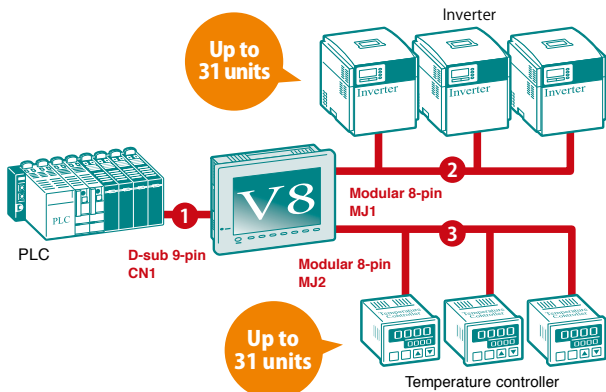

Example 2 Serial connection and Ethernet

Integrated management of up to eight kinds of devices

In addition to conventional connection with temperature controllers and PLCs via 2-way serial communication, connection via Ethernet is possible.

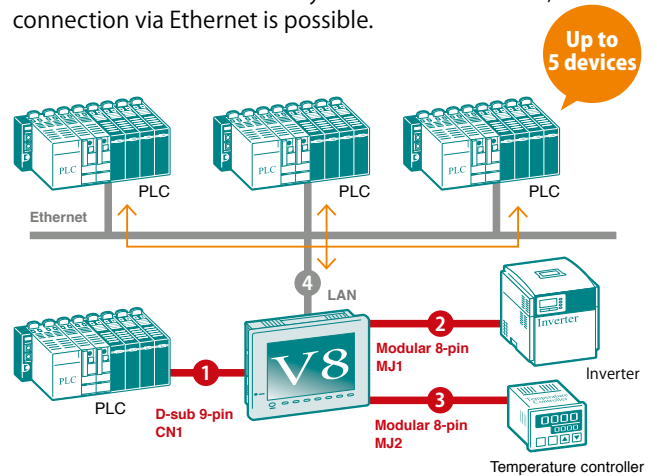

Example 3 Ethernet First in Industry

Used as a gateway for different types of networks

V8 can connect with eight kinds of PLCs via Ethernet. In addition, it can be used as a gateway with another network by adding an Ethernet port using the optional unit (CU-03-3). For example, data can be transferred between a production site and the office freely by using a V8. V8 works as the gateway of multiple networks of the production site and the office without increasing data load on the networks.

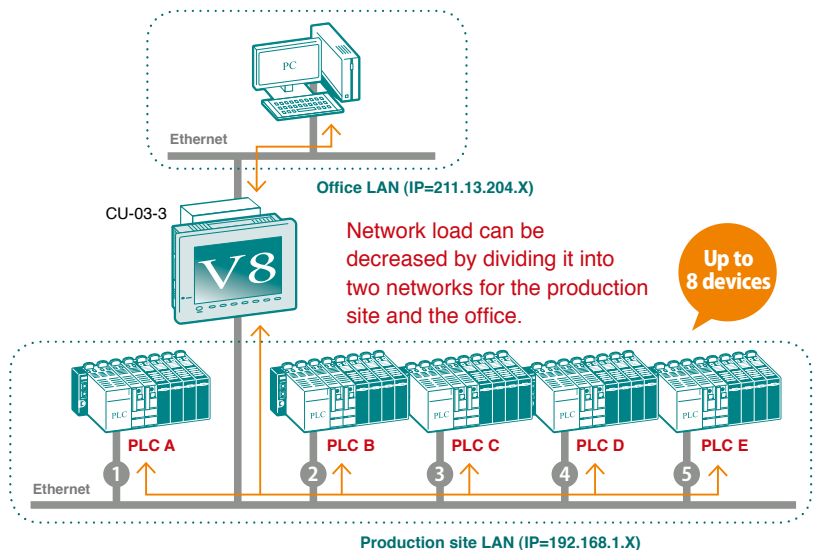

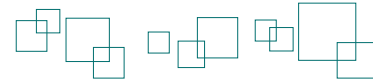

Products
Display/Operation Features
Communication Features
Expandability
Usability
Configuration Software (V-SFT)
Component Parts
Expandability with MES/Ethernet
Specifications
Dimensions and Part Names
System Configuration
Option
Option List
Customer Service
Product Warranty

A variety of ingenious uses

8-way communication offers various functions and boosts your convenience

case 1 Analysis of trouble

Integrated management of different manufacturers' PLCs

A production line that contains various manufacturers' equipment has various types of PLCs. By using 8-way communication, you can monitor the condition of all the PLCs through a V8 and analyze trouble at a remote place without visiting the site.

case 2 Reading of production conditions and set data

Connectable with various kinds of equipment

Even when the system consists of various kinds of equipment, it is easy to read and write the data of the individual units via 8-way communication. By using a V8 as a gateway, it is possible to connect with the office host system.

case 3 Real-time indication of information

High-speed data sampling

A V8 is connected to a PLC via two communication lines: one for operation/monitoring, and the other for sampling, a setup that enables high-speed and stable sampling.

Expandability (USB master/slave)

High compatibility with peripherals makes for more user-friendliness

All models are equipped with two types of USB interfaces fitted as standard feature.

High-speed transfer of large-volume data and easy connection to printers

Slave (USB-B)

PLC Ladder Program Transfer

PLC ladder programs can be written or monitored with your PC through the USB port of V8. High-speed ladder transfer is possible.



Slave Master

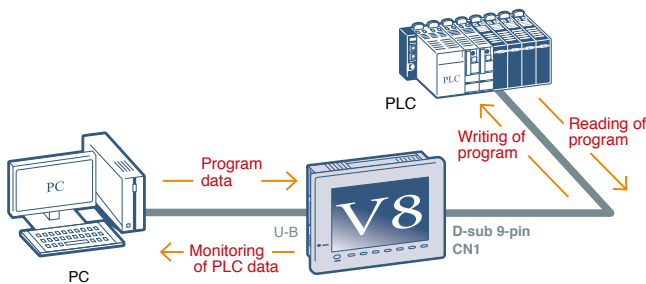

High-speed Transfer of Screen Program

Large-volume screen program edited by "V-SFT" configuration software can be downloaded and uploaded at high speed.

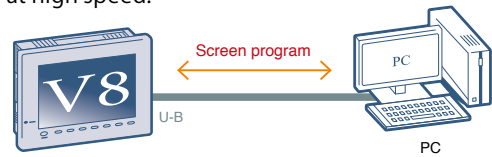

Compatible with PictBridge Printers

V8 is compatible with PictBridge printers. With PictBridge-compatible printers, production data such as daily and monthly reports can be printed out easily.

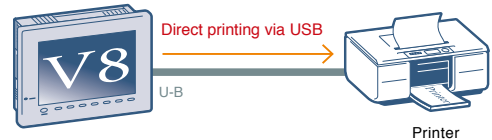

Compatible with PC peripherals including a USB keyboard and a USB mouse

Master (USB-A)

Card Reader/Writer

Connection with our "USB-CFREC" or commercial CF card readers/writers increases the versatility.

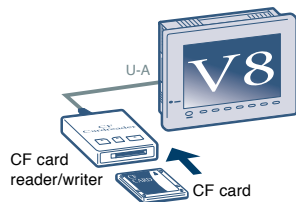

Compatible with USB Keyboard

In addition to conventional software keyboards, a USB keyboard can be connected, which facilitates the entry of long product numbers and code numbers.

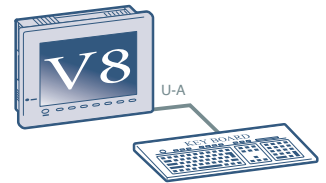

USB Interfaces Fitted on the Front

Optional interfaces "UA-FR" and "UB-FR" enable USB ports to be fitted on the front of the display for easy access.

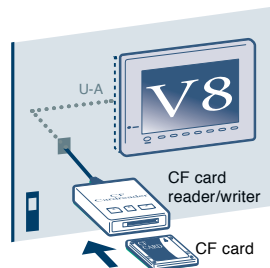

Compatible with USB Mouse

PC operation

By installing an optional RGB input unit "GU-01", "GU-10" or "GU-11", PC screen can be displayed on V8. You can operate the PC screen using a USB mouse.

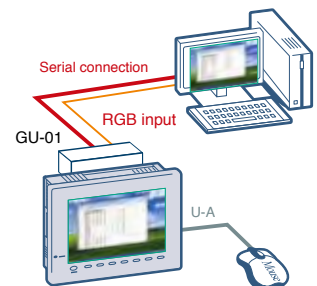

Output on Large Displays

By installing the optional RGB output unit "GU-02", V8 screen program can be displayed on a large screen and it can be operated using a USB mouse.

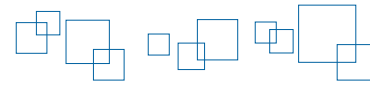

Expandability (CF Card)

For superior information management

Two-drive system for versatile uses of CF cards

CF card interface and USB reader/writer

Equipped with Two Drives

In addition to the built-in CF card interface, MONITOUCH is equipped with a USB interface for a CF card reader/writer, which can be used simultaneously. Since CF card data can be copied to another card while V8 is being used, the V8 performance will not be inhibited. These functions expand the versatility of MONITOUCH.

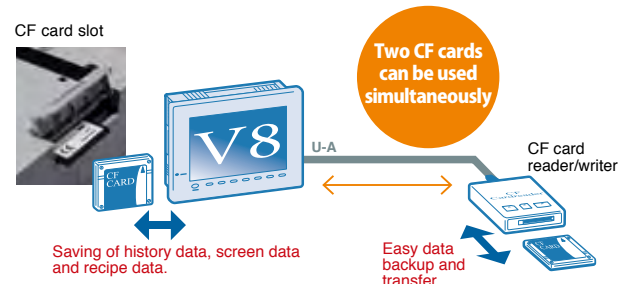

Built-in Drive for Constant Use

case 1 Recipe Data

Production conditions can be saved in a CF card in CSV format. For preparation of production, data can be read out from a CF card and written in the PLC. It is also possible to read out data from PLC.



case 2 Sampling

Production data and alarm history can be sampled and saved. Since the data is saved in CSV format, it can be easily edited in Excel.

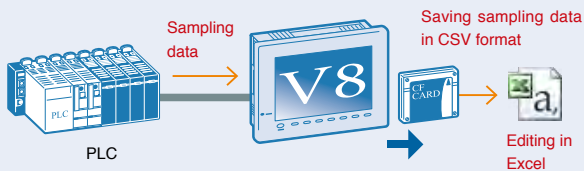

PC-friendliness

Compatible with FAT32

FAT has some limitations. For example, a file name cannot exceed eight characters in length, and extensions must be within three characters. FAT32 allows a data file to have a longer file name, which improves compatibility with PCs.

USB Drive for Easy Data Delivery

case 3 Screen Program Transfer

Because screen data can be saved on a CF card and read into V8 at a production site by means of a CF card reader/writer, there is no need to bring your PC.

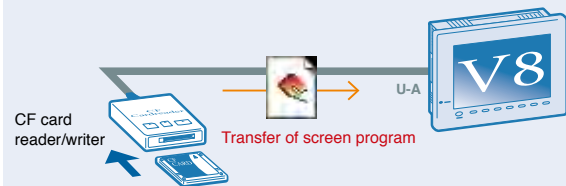

case 4 Data Transfer

While using a CF card as a built-in drive, the card data can be copied to another CF card via the USB interface. Sampling data and recipe data can be backed up easily while keeping the CF card in the slot.

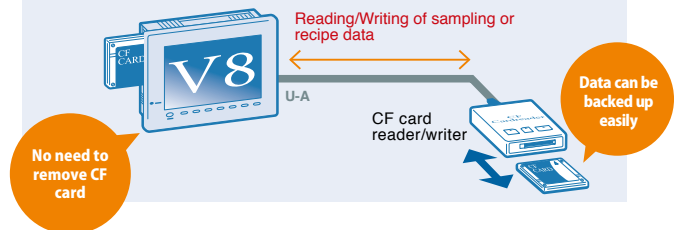

Impressive Screen

Screen program capacity can be increased by means of a CF card

A CF card can be used as an extension unit for editing the screen. You can design an impressive screen freely without having to worry about data capacity.

Products
Display/Operation Features
Communication Features
Expandability
Usability
Configuration Software (V-SFT)
Component Parts
Expandability with MESS/Ethernet
Specifications
Dimensions and Part Names
System Configuration
Option
Option List
Customer Service
Product Warranty

Easy Configuration 1

Highly functional switches

Switches with various functions are standardized. No macro or PLC ladder programming is required.

Various switches that meet the individual needs

Multi-output

In order to meet diversified needs, switches with various functions are installed.

Multi-output memory Output up to 16 positions

Switches have a multi-output function. Turning on just one switch makes the other switches turn off. It is also possible to output bit signals up to 16 positions.

For example, when you turn on one switch, the others turn off simultaneously.

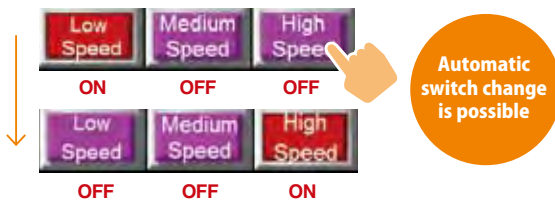

Indication depends on the value

In addition to the bit ON/OFF status, it is possible to set various switch conditions according to the value.



Setting the switch timing freely ON delay

It is possible to set switch functions such as requiring holding down the button for a certain time. This function prevents a false operation of the switch.

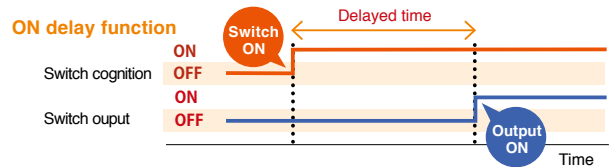

Setting the switch timing freely OFF delay

Switch output is retained for a certain time after reset of the switch.

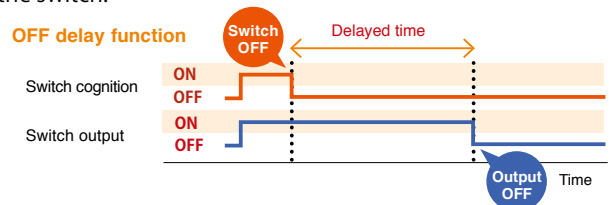

Indication according to individual production sites needs

Conditional Visibility

Static conditional visibility

You can set whether or not to show an item while creating a screen, item by item. One screen data can be utilized for different applications.

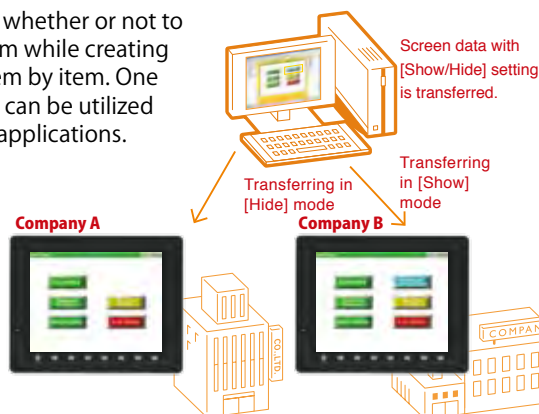

Conditional visibility according to the security level

The display can be arranged according to security level. The security level is controlled by passwords. For example, different displays are shown for a maintenance engineer and an operator.

Dynamic conditional visibility

Whether items are indicated or not is automatically determined according to the memory condition.

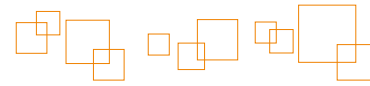

Easy Configuration 2

Convenient functions to meet users' demands

Flash ROM, a large capacity of SRAM and many other functions for more user friendliness

High-capacity memory facilitates screen design

12.5MB^{*1} Flash ROM

V8 has 12.5MB^{*1} Flash ROM as standard — twice^{*2} the capacity of our previous model. In addition, by saving data in a CF card, you can design the screen without caring memory capacity.

^{*1} SRAM capacity differs depending on the models. See Performance Specifications (P29) for details
^{*2} Comparison with V7

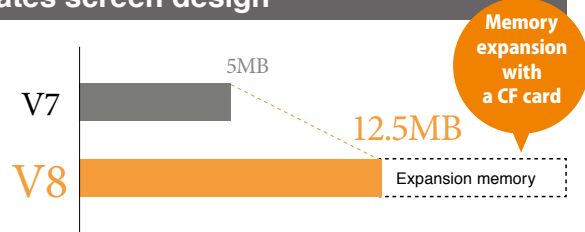

For saving large-volume event history data

512KB^{*1} SRAM as Standard

The built-in SRAM capacity has been expanded to 512KB^{*1} — eight times larger than that of our previous model. The capacity for backup of sampling data, operation information, alarm information, etc. has been greatly increased to comply with the ISO standard for information management. The large memory capacity enables quick data processing.

^{*1} SRAM capacity differs depending on the models. See Performance Specifications (P29) for details

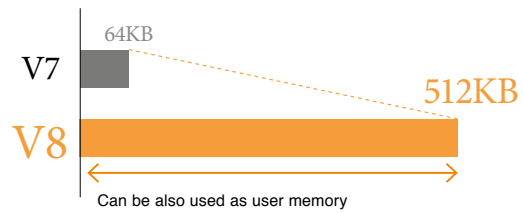

Extended screen number

Enhanced configuration function

The upper limit of the number of configurable screens is extended to 9,999. Up to 4,000 screens can be stored in a V8. Additionally they can be saved in CF card, which means you do not need to care about screen data capacity.

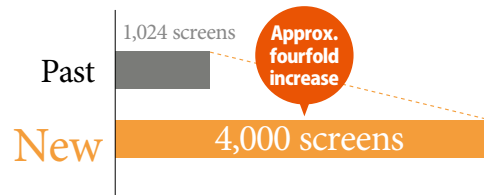

Easy-to-make pop-up message

Pop-up Window

Pop-up window is standardised. No programming or individual message edit is required for making a dialog such as an alert.



Products
Display/Operation Features
Communication Features
Expandability
Usability
Configuration Software (V-SFT)
Component Parts
Expandability with MESS/Ethernet
Specifications
Dimensions and Part Names
System Configuration
Option
Option List
Customer Service
Product Warranty

Easy Configuration 3

Enhanced interface led by the most connections in the industry

Alarm enhancement

Both a message and a parameter are loaded and displayed on the screen when any alarm happens. For example, if the water temperature gets more than 100°F, not only "caution" alarm but temperature data like "100°F! Caution" can be displayed on the screen. It is facilitated to analyze causes of failure by more detailed information.

Setting image

Parameter table

Up to 8 parameters can be registered and associated with each alarm.

No.	Memory	Type
0	D4	Message No.
1	M0	Bit
2	D5	Numerical value (one word)
3	D6	Characters (8 characters)
.	.	.
.	.	.
.	.	.

A parameter is loaded and a message that is corresponding to the situation is displayed when an alarm happens.



Message editing

Describe a parameter number that is registered when you edit a message. Then the memory that is set in the parameter is loaded and displayed when this message is displayed.

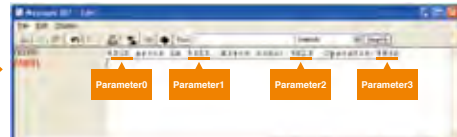

Displayed content can be saved in CF card as CSV formatted file, which makes it easier to analyze causes of failure.

Operation log

Operations such as pushing buttons on the screen and entering numbers are recorded in chronological order. By combining it with the password function, you can view "Who, When, What, & How" history to analyze causes of failure.



Operation history is saved as a binary file. You do not have to be worried about falsification of data.

Items	Timing to save
Start	When turning on power
Transfer	During the transfer time of screen data or I/F driver
Mode switching	When switching between RUN screen and Main Menu screen
Screen switching	When switching screens
Language switching	When switching languages
Switch operation	When pushing on the switch
Data display updating*	When changing Number display/String display depending upon input modes
Log discarding	When clearing SRAM data and save a new log

*Tabla Data Display is not supported.

By easy installation of checking "registration of operation log viewer", all functions of the viewer can be used.

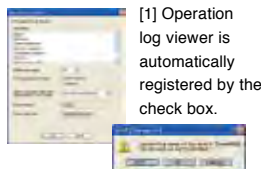

[1] Operation log viewer is automatically registered by the check box.

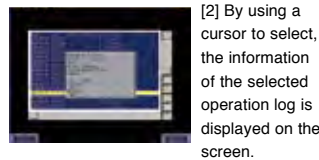

[2] By using a cursor to select, the information of the selected operation log is displayed on the screen.



[3] Setting such as Display/Hide of items and number of characters can be customized as you like.

CSV conversion

The binary file of operation history which was saved in a CF card can be converted to a CSV file by using a dedicated tool.

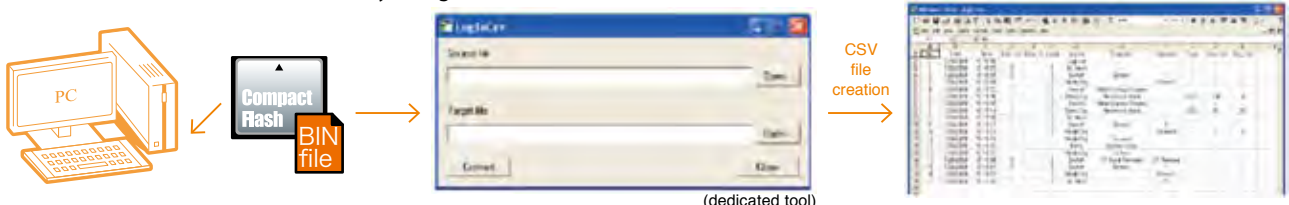

(dedicated tool)

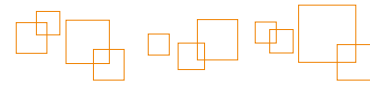

Easy Configuration 4

Multi-link 2 Ethernet function

Conditional visibility of trend sampling data

You can select a waveform of trend sampling and display/hide it.



Screen sharing is achieved as the waveform that is appropriate for the machine specifications can be selected.

Supporting portrait orientation

You can edit V806 series screen as a longitudinal type image.



This function is the most appropriate for the machine without enough horizontal spaces.

Note) Not available with monochrome type.

Function security

Security levels from 0 to 15 can be set per screen. By setting function limit appropriate for each user, highly secured environment can be established.



Screen 2 (Level 3)

On the moving to Screen 5

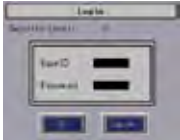

Password input screen is automatically displayed.

Users higher than Screen 5



Screen 5 (Level 5)

Interlock of the switch

Security levels can be set in the switches as well. Only those who login with an appropriate levels can use the switches.

Multi-link 2 via Ethernet

Multi-link 2 connection via Ethernet is supported. When connecting multiple V8s to one PLC, much faster transferring can be achieved comparing to existing multi-link.

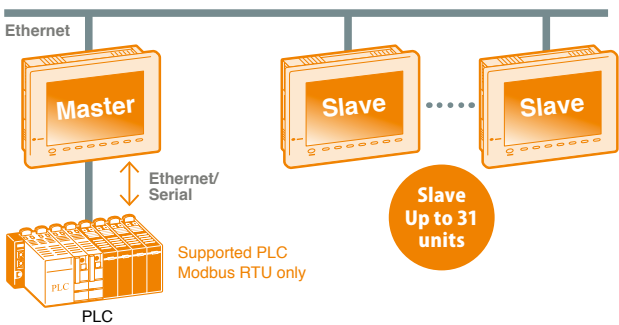

Added macros

Mathematics/trigonometric function macros

Commands regarding to trigonometric function such as sine (SIN), cosine (COS) and tangent (TAN), absolute value and sign inversion are added.

CF card (sampling) macros

You can save a sampling data of buffering area in any file name as a CSV file.

Control statement macros

"IF ~ ELSE" statement is supported. You can write shortly and easily condition comparison macros.

CF card (hard copy) macros

You can save an image on the screen in any file name.

Products
Display/Operation Features
Communication Features
Expandability
Usability
Configuration Software (V-SFT)
Component Parts
Expandability with MESS/Ethernet
Specifications
Dimensions and Part Names
System Configuration
Option
Option List
Customer Service
Product Warranty

Configuration Software [V-SFT]

New V-SFT for easy screen configuration

Multiple windows provides immediate access to all application data.

Overall View of All the Devices

Project View (1)

- System tree diagrams show the configuration of files and screens in the entire system.
- Easy viewing and modification of the contents and configuration of each block.

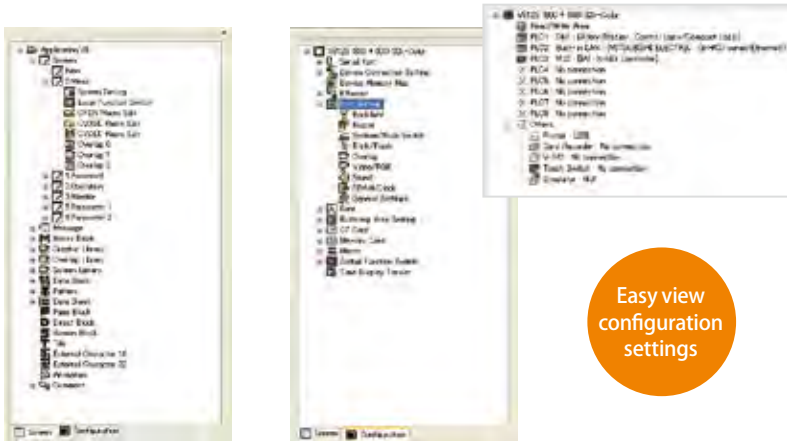

Easy view configuration settings

[Screen] and [Configuration] windows are easily switched by clicking tabs.

Quick Debugging on Your PC

Emulation function for Easy Debugging

With the emulator of V-SFT Ver.5, data debugging is possible on your PC without V8 or PLC.

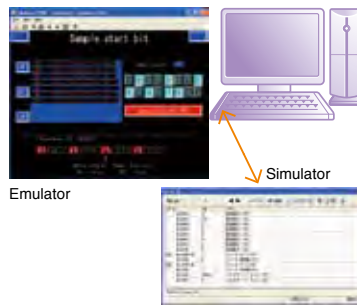

Quick Arrangement with Component Parts

Parts View (2)

- Various parts are listed for each item.
- Select a part, and drag & drop it on the configuration window.

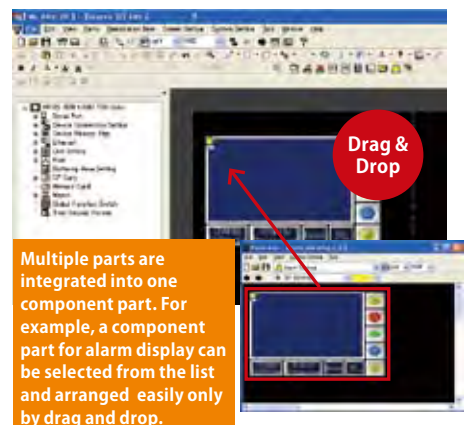

Multiple parts are integrated into one component part. For example, a component part for alarm display can be selected from the list and arranged easily only by drag and drop.

MONITOUCH V-SFT Ver. 5

■ V-SFT Requirements

PC	PC/AT compatible machine with Windows
OS	Windows 98/ Me/ NT Version 4.0/ 2000/ XP/ XP 64 edition/ Vista 32bit*
CPU	Pentium III 800 MHz or higher (Pentium IV 2.0 GHz or higher is recommended.)
Memory	512 MB or more
Hard disk	For installation: 850 MB or more available space
CD-ROM Disk drive	24 times or faster
Display	Resolution of 1,024 × 800 (XGA) or higher
Color indication	High color (16 bit) or higher

* When installing in Windows NT Ver.4/ 2000/ XP/ XP 64 edition/ Vista 32bit, administrator authority is required.



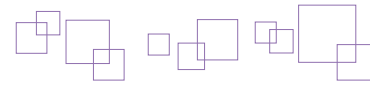

Easy and Speedy Display Configuration

Auto Size Change

When using screen data from a panel with different screen resolution, screen size is automatically adjusted to your selected model.

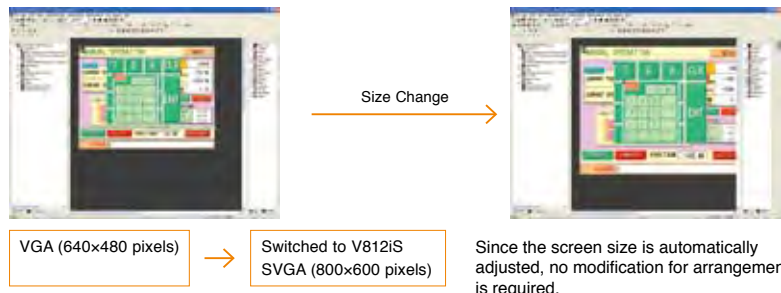

Convenient Item View (3)

Direct editing

Memory condition, coordinates, switch names can be entered in the item view.
Memory address, position, and text can be directly entered in the item list.

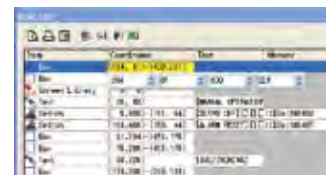

Easy editing by selecting items

Coordinate items view

Utilize [Display setting] in the item list to minimize or maximize item properties in the windows. This system facilitates efficient management of information.



Enhanced Batch Change Functions

Additional items for batch change

More items can be changed simultaneously by batch change.

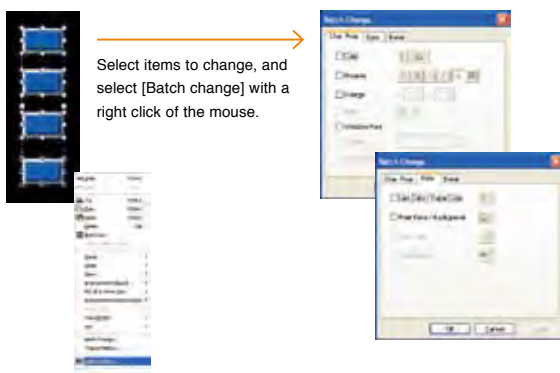

Batch change with the item view (4)

Multiple items can be selected to change the setting simultaneously on the item view window.

<Available items>

Switches, lamps, values, characters, messages, bar/circle graphs, panel meters, closed-area/statistical graphs

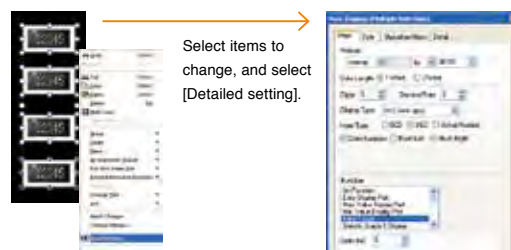

- Products
- Display/Operation Features
- Communication Features
- Expandability
- Usability
- Configuration Software (V-SFT)
- Component Parts
- Expandability with MESS/Ethernet
- Specifications
- Dimensions and Part Names
- System Configuration
- Option
- Option List
- Customer Service
- Product Warranty

Component Parts

“Component Parts” facilitate screen configuration.

Convenient tool assists you in creating functional screens instantly.

Quick screen configuration using integrated “Component Parts”

Component Parts

First in Industry

In “Component Parts,” various functions and macros have been arranged according to purpose. You can create a functional screen instantly by simply selecting a “Component Part” from the parts list and placing it on the screen.

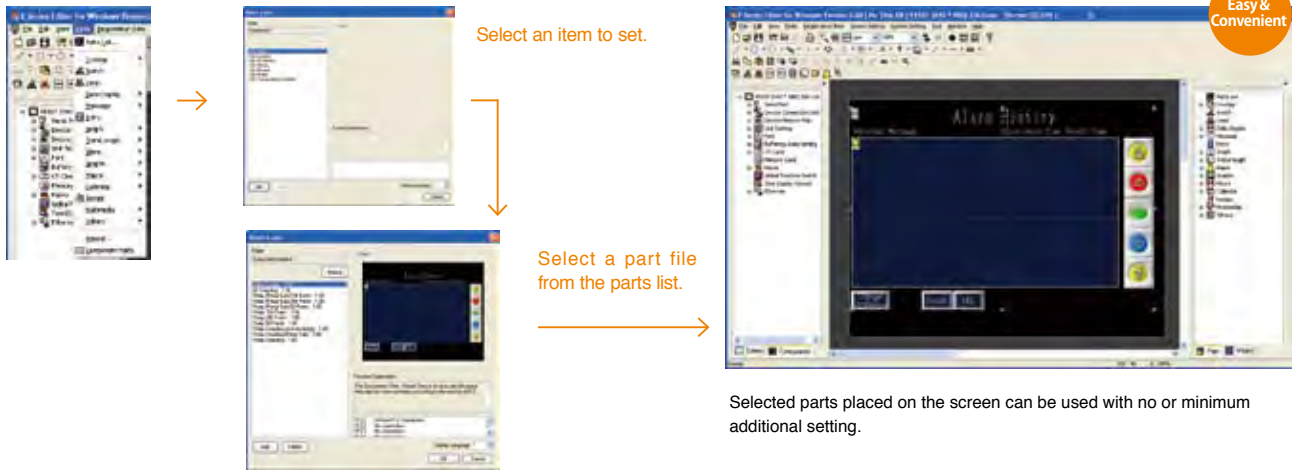

Point 1 Easy Screen Configuration

You can create multifunctional screens using integrated “Component Parts.” When arranging on a screen that contains other messages or setting windows, a “Component Part” can be used regardless of overlapping of settings or windows.

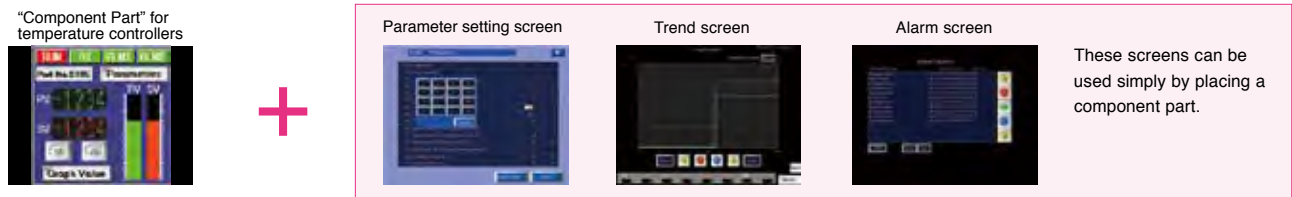

Point 2 Easy Utilization of Resource

“Component Parts” contain all necessary settings for operation, so they don’t need any additional settings when used on other displays. They can be reused simply by copying and pasting.

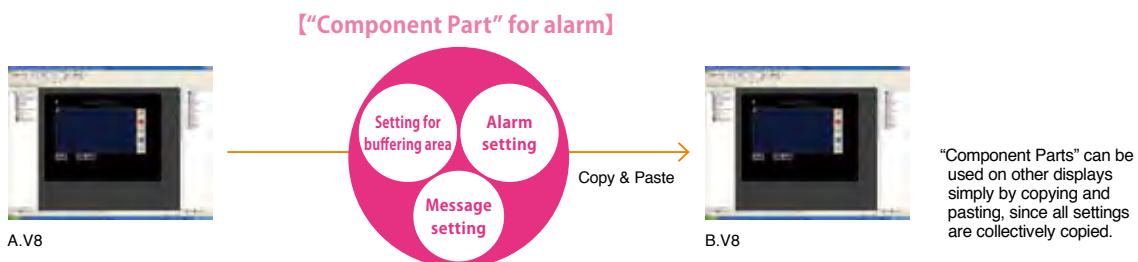

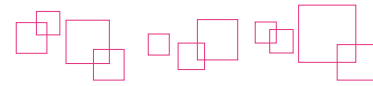

Products
Display/Operation Features
Communication Features
Expandability
Usability
Configuration Software (V-SFT)
Component Parts
Expandability with MES/Ethernet
Specifications
Dimensions and Part Names
System Configuration
Option
Option List
Customer Service
Product Warranty

Point 3 Simple Setting View

After placing "Component Parts," they can be easily used simply by setting addresses and texts.

Example of Setting View ("Component Part" for alarm history)

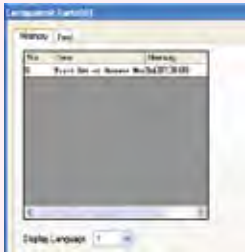

Example of Setting View ("Component Part" for alarm history)
Set an address for alarm monitoring.

Memory setting

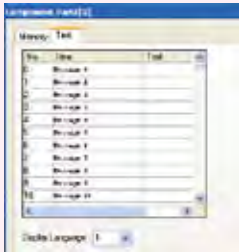

Set a text for each alarm message.

Text setting

Easy and simple

All settings for alarm history can be edited in one menu.

Point 4 Batch Change of Addresses/Texts

When the same address or text is used for multiple screens, all the settings can be changed simultaneously on the setting view simply by registering it in the address/text table of a "Component Part."

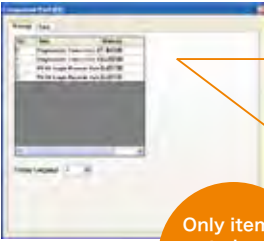

[Memory setting]



Screen 1



Screen 2

Only items to be changed are listed.

Point 5 Authorization by Passwords

Setting a password for a "Component Part" prevents the settings for the part from being changed by unauthorized persons. Customers can use a "Component Part" without having to worry about tampering of the setting.



No worry about tampering

Point 6 Various "Component Parts"

"Component Parts" with various functions are available. They can be selected from the parts list according to your purpose to configure displays promptly.

Examples of "Component Parts"

Temperature controller



Displays for monitoring and parameter setting of temperature controllers can be made easily.

Inverter



Displays for monitoring and parameter setting of inverters can be made easily.

Robot controller



Displays for monitoring and operation setting of robots can be made easily.

I/O monitor

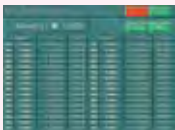

Displays for I/O monitoring of PLCs can be made easily.

Date setting



Displays for date setting can be made easily.

Ethernet expansion

Advanced feature based on Ethernet

Efficient line monitoring by network cameras

Network camera

Displays images from cameras connected to Ethernet on a V8 screen. You can efficiently achieve monitoring of a remote location and a whole line.

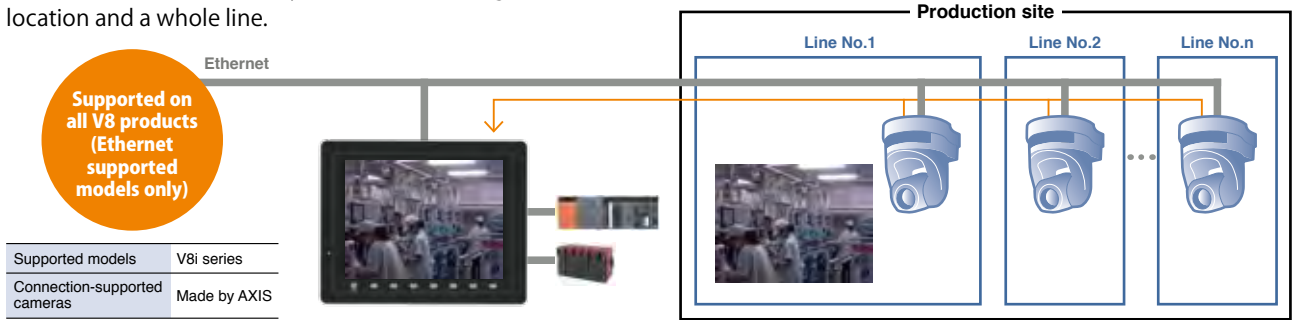

Cameras that support spinning and zooming functions can receive a command from MONITOUCH.

[1] Spinning of a camera (supported cameras only)

You can change the direction of a network camera from a remote location.



[2] Zooming of a camera (supported cameras only)

You can zoom in and out an image from a remote location.



Application software that connects your office with your production site at low cost. **TELLUS and V-Server**

"Ability of Factory" is enhanced by the remote function and the data collection function.

In the environment with a V-Server installed PC, you can monitor and control your production site from a remote location, even if you are in a foreign country.

[TELLUS and V-Server]

Features such as data collection and data management functions are available for collecting information on the production site in real time to manage it with Excel/CSV files. Additionally, you can monitor and control TELLUS-HMI and MONITOUCH from a remote location.



(Example) Industrial PC

Expanded possibilities by working together with Windows applications.

1 Working with VB programs

By creating VB programs using TELLUS access function, you can access TELLUS. Complicated arithmetic processing are done by VB programs and the result is displayed on TELLUS.

2 Working with optional units

It can be smoothly connected to a Windows printer. You can easily print out daily reports, monthly reports, information on lines and machines operation. Additionally, you can use high-capacity storage and memory.

3 Working with database

By using TELLUS and V-Server, you can work together with database such as SQL Sever. Tabulation of production achievement and storing of data on the number of defected products and causes of failure can easily be done.

4 Working with MONITOUCH

You can monitor multiple MONITOUCH installed on the machines from a remote location. And you can also collect production data and change machine settings by the recipe function.

Ethernet expansion

Use Remote Desktop to make use of Windows applications

Enhanced maintenance capacity led by Windows applications

Remote Desktop

By connecting to Ethernet, the server PC's screen is displayed on the V8 screen. At a production site where no PC can be set, you can operate the functions of PC from V8.

Supported models V815iX, V812iS, V810iS, V810iT, V808iS, V810iC, V808iC, V808iCH, V806iT, V806iC

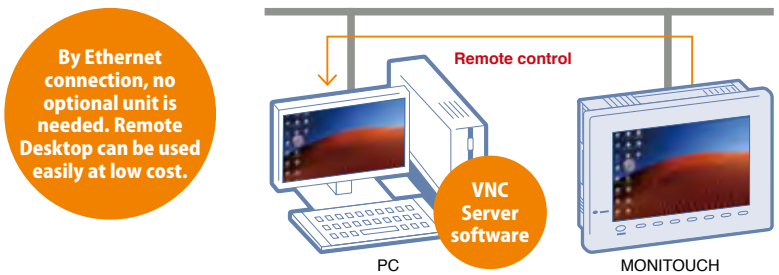

Application 1 Viewing operating instructions and manuals

By remote-controlling a PC connected via Ethernet from a V8 series, you can view operating instructions and manuals stored on the PC.

Application 2 Ladder monitoring/ladder editing

By starting a ladder software installed in the PC that is connected via Ethernet and activating the ladder transfer function, you can monitor/edit the ladder program of the connected PLC on V8.

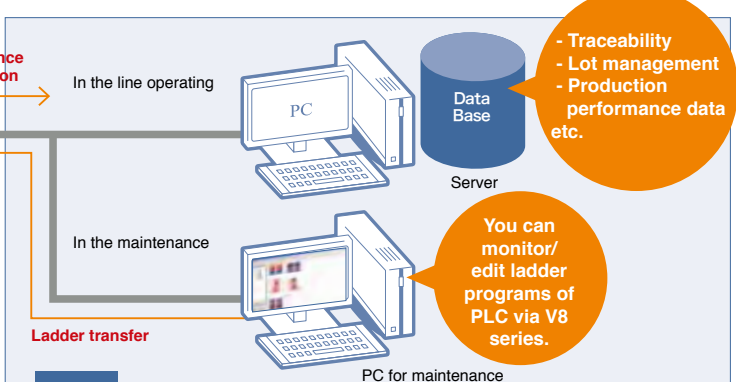
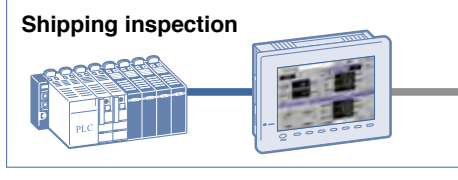
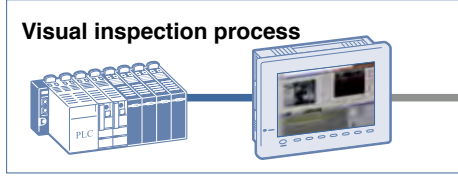
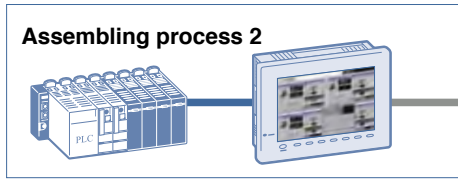
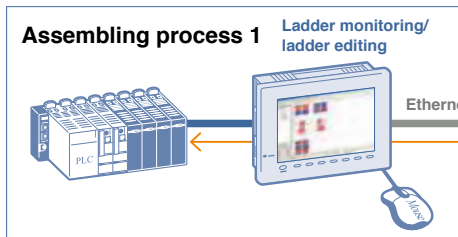
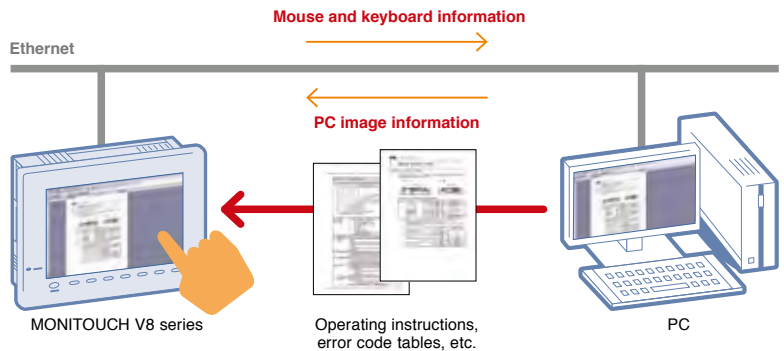

Point 1 PLC Ladder program transfer via Ethernet

You can monitor/edit ladder programs on all machines that are connected via Ethernet.

Supported PLCs	Mitsubishi Electric	QnH(Q)series CPU, Q00J/00/01 CPU, QnUseries CPU, QnH(Q)series CPU(Multi CPU)
	Fuji Electric	MICREX-SX SPH/SPB CPU

Point 2 USB keyboard supported

Ladder editing is also possible by USB keyboard.

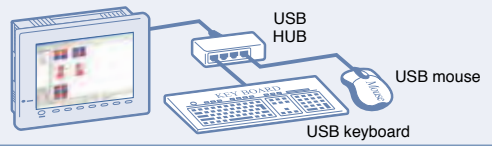

Useful

Easy to modify circuits and edit comments on V8.

- Products
- Display/Operation Features
- Communication Features
- Expandability
- Usability
- Configuration Software (V-SFT)
- Component Parts
- Expandability with MESS/Ethernet
- Specifications
- Dimensions and Part Names
- System Configuration
- Option
- Option List
- Customer Service
- Product Warranty

MES*

Supporting the construction of advanced MES

V8 networking promotes the integration of sales, production management and manufacturing at low cost.

Reinforcing your production management through connection to the database

MES* interface function

Data for production records, defect quantity, error causes and various kinds of information can be sent to the MES database server via V-Server in SQL. Communication with the database is possible without a gateway PC or complicated programming.

No Programming Required

Data can be saved in the database server by simple setting on V-SFT — no programming is required.

Preventing data loss

All data transferred to the database is saved with the error log so that it is completely secure.

Decreasing system load

Data can be transferred to the database server when conditions are fulfilled. The server does not need to keep monitoring production, so the load on the system can be decreased.

* [MES]: The "Manufacturing Execution System" is for optimizing product quality, product quantity, delivery date, cost, etc. in the management/control of production sites.

V-Server

The V-Server realizes production data collection and production control via LAN. One V-Server can control multiple V8 units without adding optional functions to V8.

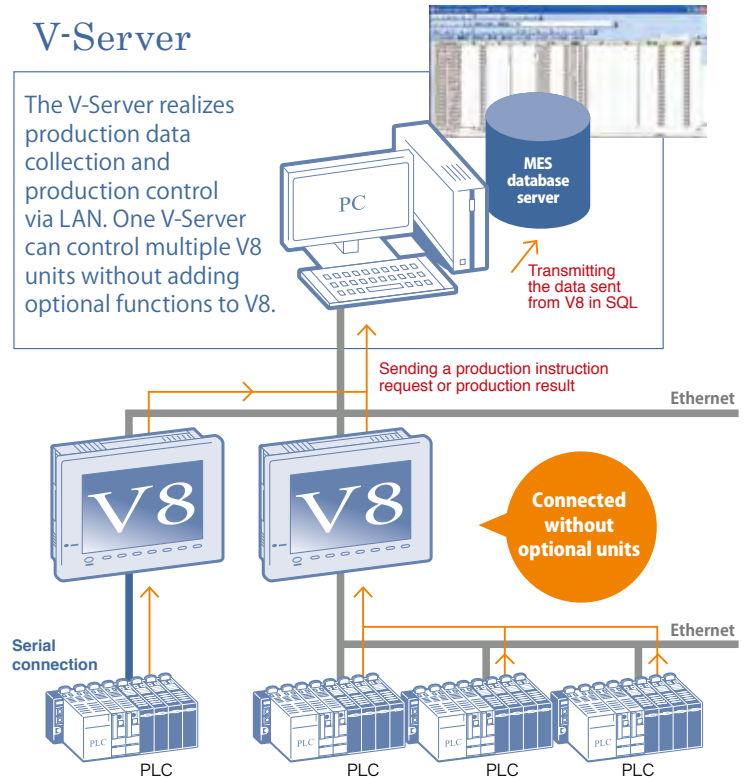

Easy MES setting!

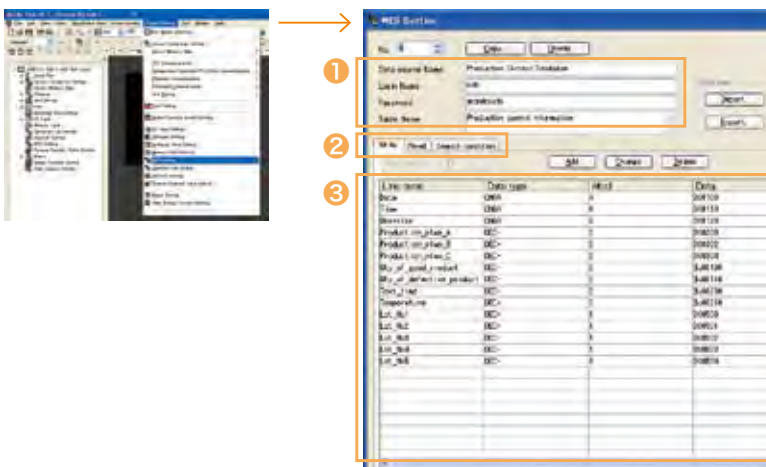

Setting to access ODBC(1)

- Set a data source name, login name and password of the database.

Setting of operation to access the database(2)

- Three types (Writing, Loading, and Loading with search criteria) are supported:
 - [Writing]
Set contents to write to the database.
 - [Loading]
Set contents to load from the database.
 - [Loading with search criteria]
Set this when loading from the database with search criteria.

Setting of items to access ODBC(3)

- Set column names and data format to access the database.

You can set PLC register or MONITOUCH internal memory as a data to write to or to load from as well.

[ODBC] Open DataBase Connectivity
Standard specifications of software to access database, which is being advocated by Microsoft.



Specifications

High-end specifications open up new possibilities.

General Specifications

Item	Model	V815		V812	
		V815iX	V815iXD	V812xS	V812xSD
Power supply	Rated voltage	AC100 ~ 240V	DC24V	AC100 ~ 240V	DC24V
	Permissible range of voltage	AC100 ~ 240V±10%	DC24V±10%	AC100 ~ 240V±10%	DC24V±10%
	Permissible momentary power failure	Within 20ms	Within 1ms	Within 20ms	Within 1ms
	Demand (maximum rating)	90VA or less	40W or less	70VA or less	30W or less
	Inrush current	20A,10ms(AC100V) / 40A,10ms(AC200V)	30A,1ms(DC24V)	20A,10ms(AC100V) / 40A,10ms(AC200V)	30A,1ms ^{*3}
Insulation resistance	DC500V 10MΩ or more				
Physical environment	Ambient temperature	0°C ~ +40°C ^{*1}		0°C ~ +50°C ^{*1}	
	Storage temperature	-10°C ~ +50°C ^{*1}		-10°C ~ +60°C	
	Ambient humidity	85%RH or less(without dew condensation, Max. wet bulb temperature: 39°C or lower) ^{*1}			
	Resistance to solvent	No attachment of cutting oil or organic solvent			
	Atmosphere	Not exposed to corrosive gas or conductive dust			
	Operation altitude	2,000 meter or lower			
Contamination level ^{*2}	Level 2				
Mechanical operating conditions	Resistance to oscillation	Vibration frequency: 10~150Hz, acceleration: 9.8m/s ² (1.0G) pulsating width: 0.075mm, X,Y,Z: 3 directions 1 hour each way			
	Resistance to shock	Pulse shape: half-sine, peak acceleration: 147m/s ² (15G), X,Y,Z: 3 directions, six times each way			
Electric operating conditions	Noise proof	1500Vp-p (pulse width 1μs, pulse rise time : 1ns)	1000Vp-p (pulse width 1μs, pulse rise time : 1ns)	1500Vp-p (pulse width 1μs, pulse rise time : 1ns)	
	Static discharge	Complies with IEC61000-4-2, contact: 6kV, air: 8kV			
Installation conditions	Grounding	Grounding resistance : Less than 100Ω , FG/SG separation			
	Structure	Protect structure: Front panel: Compatible with IP65 (when water-proof gasket is used.) Rear cover: Compatible with IP20 Form: Single unit Installation method: Panel mounting			
	Cooling system	Natural air cooling			
	Weight	Approx.5.5kg	Approx.5.3kg	Approx.2.9kg	
	Dimensions WxHxD(mm)	382.8x312.8x81.1		326.4x259.6x69.0	
	Panel cutout (mm)	369.4x299.4(+0.5/-0)		313.0x246.2(+0.5/-0)	
Case color	-		Gray		
Material	Aluminium		PC/ABS		

*1 Keep wet bulb temperature under 39°C to avoid an accident.

*2 Contamination level is an index that shows the incidence rate of conductive substance. At Level 2, only nonconductive substance is produced, but a temporary conductive state may occur due to dew concentration.

*3 Hardware version: j or later

Performance Specifications

Item	Model	V815iX	V815iXD	V812iS	V812iS
Display specifications	Screen memory	12.5MB			
	Display device	TFT color LCD			
	Resolution W:H(dots)	1024x768		800x600	
	Display size	15 inches		12.1 inches	
	Colors	65,536 colors (without blinks) / 32,768 colors (with blinks)			
	Backlight	CCFL			
	Backlight life ^{*5}	About 60,000 hours		About 50,000 hours	
	Backlight Auto OFF	Lit in normal (Set by the user)			
	Power lamp	Lit in normal condition, blinks in alarm condition such as blowout of backlight bulbs			
	Contrast adjustment	Fixed			
Brilliance control	3 levels (Adjusted into 128 grades by macro command)				
Number of characters	1/2-byte	127 columns x 96 lines		100 columns x 75 lines	
	1-byte	127 columns x 48 lines		100 columns x 37 lines	
	2-byte	64 columns x 48 lines		50 columns x 37 lines	
Enlargement of characters		X: 1 ~ 8 times Y: 1 ~ 8 times			
Touch switch	Switch resolution	Analogue: 1,024x1,024		Analogue: 1,024x1,024 / Matrix: 50x30	Analogue: 1,024x1,024
	Mechanical life	1 million times or more			
	Surface treatment	Hard coating, Non glare finish 5%			
Function switch	Number of function switches	8 switches			
External interface	D-Sub 9-pin (CN1)	RS-232C, RS-422/485, Asynchronous type, Data length : 7.8 bits, Parity : even, odd, none, Stop bit : 1, 2 bits, Baud rate : 4800, 9600, 19200, 38400, 57600, 76800, 115200, 187500 ^{*6} bps			
	Modular 8-pin (MJ1/ MJ2)	RS-232C, RS-422/485 (two-wire system), Asynchronous type, Data length : 7.8 bits, Parity : even, odd, none, Stop bit : 1, 2 bits, Baud rate : 4800, 9600, 19200, 38400, 57600, 76800, 115200 bps			
	CF card interface	Compatible with CompactFlash™			
	Ethernet ^{*4}	Complies with IEEE802.3, Baud rate: 100Mbps, 10Mbps Cable: 100Ω Unshielded twist pair, Category 5, Max length: 100m			
	USB	Type A, Type B (Ver1.1)			
Clock & Back up memory	Battery	Coin-type lithium primary battery			
	Back up memory (SRAM)	512KB			
	Back up period	5 years (Ambient temperature 25°C)			
Calendar accuracy	Gap±90 sec. per month (Ambient temperature 25°C)				

*4 Standard equipment only for V8i series

*5 When the panel surface luminance drops to 50% of the initial value at normal temperature (25°C)

*6 Available only when connected with SIEMENS MPI.

Products
Display/ Operation Features
Communication Features
Expandability
Usability
Configuration Software (V-SFT)
Component Parts
Expandability with MES/ Ethernet
Specifications
Dimensions and Part Names
System Configuration
Option
Option List
Customer Service
Product Warranty

Specifications

General Specifications

Item	Model	V810				V808	
		V810xS / V810xT	V810xC	V810xSD / V810xTD	V810xCD	V808xSD	V808xCD
Power supply	Rated voltage	AC100 ~ 240V		DC24V		DC24V	
	Permissible range of voltage	AC100 ~ 240V±10%		DC24V±10%		DC24V±10%	
	Permissible momentary power failure	Within 20ms		Within 1ms		Within 1ms	
	Demand (maximum rating)	70VA or less	60VA or less	25W or less	20W or less	23W or less	20W or less
	Inrush current	20A,10ms(AC100V) 40A,10ms(AC200V)	16A,6ms(AC100V) 32A,7ms(AC200V)	30A,1ms (DC24V) *3	20A,1ms (DC24V)	30A,1ms(DC24V) *3	20A,1ms(DC24V)
Insulation resistance	DC500V 10MΩ or more						
Physical environment	Ambient temperature	0°C ~ +50°C *1					
	Storage temperature	-10°C ~ +60°C					
	Ambient humidity	85%RH or less(without dew condensation, Max. wet bulb temperature: 39°C or lower) *1					
	Resistance to solvent	No attachment of cutting oil or organic solvent					
	Atmosphere	Not exposed to corrosive gas or conductive dust					
	Operation altitude	2,000 meter or lower					
Contamination level *2	Level 2						
Mechanical operating conditions	Resistance to oscillation	Vibration frequency: 10~150Hz, acceleration: 9.8m/s ² (1.0G) pulsating width: 0.075mm, X,Y,Z: 3 directions 1 hour each way					
	Resistance to shock	Pulse shape: half-sine, peak acceleration: 147m/s ² (15G), X,Y,Z: 3 directions, six times each way					
Electric operating conditions	Noise proof	1500Vp-p (pulse width 1μs, pulse rise time : 1ns)					
	Static discharge	Complies with IEC61000-4-2, contact: 6kV, air: 8kV					
Installation conditions	Grounding	Grounding resistance : Less than 100Ω , FG/SG separation					
	Structure	Protect structure: Front panel: Compatible with IP65 (when water-proof gasket is used.) Rear cover: Compatible with IP20 Form: Single unit Installation method: Panel mounting					
	Cooling system	Natural air cooling					
	Weight	Approx.2.5kg			Approx.1.5kg		
	Dimensions WxHxD(mm)	303.8x231.0x69.0			233.0x178.0x65.8		
Panel cutout (mm)	289.0x216.2(+0.5/-0)			220.5x165.5(+0.5/-0)			
Case color	Gray						
Material	PC/ABS						

*1 Keep wet bulb temperature under 39°C to avoid an accident.

*2 Contamination level is an index that shows the incidence rate of conductive substance. At Level 2, only nonconductive substance is produced, but a temporary conductive state may occur due to dew concentration.

*3 Hardware version: j or later.

Performance Specifications

Item	Model	V810iS	V810S	V810iT	V810T	V810iC	V810C	V808iS	V808S	V808iC	V808C
Display specifications	Screen memory	12.5MB				4.5MB		12.5MB		4.5MB	
	Display device	TFT color LCD									
	Resolution W:H(dots)	800x600		640x480		800x600		640x480			
	Display size	10.4 inches				8.4 inches					
	Colors	65,536 colors (without blinks) / 32,768 colors (with blinks)									
	Backlight	CCFL									
	Backlight life *5	About 50,000 hours									
	Backlight Auto OFF	Lit in normal (Set by the user)									
	Power lamp	Lit in normal condition, blinks in alarm condition such as blowout of backlight bulbs									
	Contrast adjustment	Fixed									
Brilliance control	3 levels (Adjusted into 128 grades by macro command)										
Number of characters	1/2-byte	100 columns x 75 lines		80 columns x 60 lines		100 columns x 75 lines		80 columns x 60 lines			
	1-byte	100 columns x 37 lines		80 columns x 30 lines		100 columns x 37 lines		80 columns x 30 lines			
	2-byte	50 columns x 37 lines		40 columns x 30 lines		50 columns x 37 lines		40 columns x 30 lines			
Enlargement of characters	X: 1 ~ 8 times Y: 1 ~ 8 times										
Touch switch	Switch resolution	Analog: 1,024x1,024		Analog: 1,024x1,024 / Matrix: 40x24		Analog: 1,024x1,024					
	Mechanical life	1 million times or more									
	Surface treatment	Hard coating, Non glare finish 5%									
Function switch	8 switches										
External interface	D-Sub 9-pin (CN1) *6	RS-232C, RS-422/485, Asynchronous type, Data length : 7,8 bits, Parity : even, odd, none, Stop bit : 1,2 bits, Baud rate : 4800, 9600, 19200, 38400, 57600, 76800, 115200,187500 ⁸ bps									
	Modular 8-pin (MJ1/ MJ2)	RS-232C, RS-422/485 (two-wire system), Asynchronous type, Data length : 7,8 bits, Parity : even, odd, none, Stop bit : 1,2 bits, Baud rate : 4800, 9600, 19200, 38400, 57600, 76800, 115200 bps									
	CF card interface	Compatible with CompactFlash™									
	Ethernet *4	Complies with IEEE802.3 Baud rate: 100Mbps, 10Mbps, Cable: 100Ω Unsealed twist pair, Category 5, Max length: 100m									
Clock & Back up memory	USB	Type A, Type B (Ver1.1)									
	Battery	Coin-type lithium primary battery									
	Back up memory (SRAM)	512KB		128KB		512KB		128KB			
	Back up period	5 years (Ambient temperature 25°C)									
Calendar accuracy	Gap±90 sec. per month (Ambient temperature 25°C)										

*4 Standard equipment only for V8i series

*5 When the panel surface luminance drops to 50% of the initial value at normal temperature (25°C)

*6 Available only when connected with SIEMENS MPI.



Products
 Display/Operation Features
 Communication Features
 Expandability
 Usability
 Configuration Software (V-SFT)
 Component Parts
 Expandability with MES/Ethernet
 Specifications
 Dimensions and Part Names
 System Configuration
 Option
 Option List
 Customer Service
 Product Warranty

General Specifications

Item	Model	V806		V808CH	
				V808iCHx	V808CHx
Power supply	Rated voltage	DC24V			
	Permissible range of voltage	DC24V±10%			
	Permissible momentary power failure	Within 1ms			
	Demand (maximum rating)	15W or less	10W or less		
	Inrush current	17A,2ms(DC24V)	15A,1.5ms(DC24V)		
Insulation resistance	DC500V 10MΩ or more				
Physical environment	Ambient temperature	0°C ~ +50°C *1		0°C ~ +40°C *1	
	Storage temperature	-10°C ~ +60°C *1			
	Ambient humidity	85%RH or less(without dew condensation, Max. wet bulb temperature: 39°C or lower) *1			
	Resistance to solvent	No attachment of cutting oil or organic solvent			
	Atmosphere	Not exposed to corrosive gas or conductive dust			
	Operation altitude	2,000 meter or lower			
Contamination level *2	Level 2				
Mechanical operating conditions	Resistance to oscillation	Vibration frequency: 10~150Hz, acceleration: 9.8m/s ² (1.0G) pulsating width: 0.075mm, X,Y,Z: 3 directions 1 hour each way			
	Resistance to shock	Pulse shape: half-sine, peak acceleration: 147m/s ² (15G), X,Y,Z: 3 directions, six times each way			
Electric operating conditions	Noise proof	1500Vp-p (pulse width 1μs, pulse rise time : 1ns)		1000Vp-p (pulse width 1μs, pulse rise time : 1ns)	
	Static discharge	Complies with IEC61000-4-2, contact: 6kV, air: 8kV			
Installation conditions	Grounding	Grounding resistance : Less than 100Ω , FG/SG separation			
	Structure	Protect structure: Front panel: Compatible with IP65 (when water-proof gasket is used.) Rear cover: Compatible with IP20 Form: Single unit Installation method: Panel mounting		IP65-compliant (when I/F cover, CF cover and LAN cover are used)	
	Cooling system	Natural air cooling			
	Weight	Approx.740g		Approx.1.2kg	
	Dimensions WxHxD(mm)	182.5x138.8x50.8		259.0x232.0x55.0 (Excluding the emergency stop switch)	
	Panel cutout (mm)	174x131(+0.5/-0)			
Case color	Gray		Black		
Material	PC/ABS				

*1 Keep wet bulb temperature under 39°C to avoid an accident.

*2 Contamination level is an index that shows the incidence rate of conductive substance. At Level 2, only nonconductive substance is produced, but a temporary conductive state may occur due to dew concentration.

Performance Specifications

Item	Model	V806iT	V806T	V806iC	V806C	V806iM	V806M	V808iCHx	V808CHx
		Screen memory	4.5MB						12.5MB
Display specifications	Display device	TFT color LCD		STN color LCD		STN monochrome LCD		TFT color LCD	
	Resolution W:H(dots)	320x240		320x240		320x240		640x480	
	Display size	5.7 inches						7.5 inches	
	Colors	65,536 colors (without blinks) / 32,768 colors (with blinks)				16 grayscale (with blinks)		65,536 colors (without blinks) / 32,768 colors (with blinks)	
	Backlight	CCFL							
	Backlight life *4	About 50,000 hours		About 75,000 hours		About 58,000 hours		About 50,000 hours	
	Backlight Auto OFF	Lit in normal (Set by the user)							
	Power lamp	Lit in normal condition, blinks in alarm condition such as blowout of backlight bulbs							
	Contrast adjustment	Fixed		Adjustable (Function switch or macro switch)				Fixed	
	Brilliance control	3 levels (Adjusted into 128 grades by macro command)		Fixed					
Number of characters	1/2-byte	40 columns x 30 lines						80 columns x 60 lines	
	1-byte	40 columns x 15 lines						80 columns x 30 lines	
	2-byte	20 columns x 15 lines						40 columns x 30 lines	
Enlargement of characters	X: 1 ~ 8 times Y: 1 ~ 8 times								
Touch switch	Switch resolution	Analog: 1,024x1,024							
	Mechanical life	1 million times or more							
	Surface treatment	Hard coating, Non glare finish 5%							
Function switch	Number of function switches	6 switches						12 switches (4 switches: external output)	
	D-Sub 9-pin (CN1) *6 TB3 for V808iCHx/ V808CHx	RS-232C, RS-422/485 (two-wire system), Asynchronous type, Data length : 7.8 bits, Parity : even, odd, none, Stop bit : 1.2 bits, Baud rate : 4800, 9600, 19200, 38400, 57600, 76800, 115200 bps						RS-232C, Asynchronous type, Data length : 7.8 bits, Parity : even, odd, none, Stop bit : 1.2 bits, Baud rate : 4800, 9600, 19200, 38400, 57600, 76800, 115200 bps	
External interface	Modular 8-pin (MJ1/ MJ2) TB2 for V808iCHx/ V808CHx	RS-232C, RS-422/485, Asynchronous type, Data length : 7.8 bits, Parity : even, odd, none, Stop bit : 1.2 bits, Baud rate : 4800, 9600, 19200, 38400, 57600, 76800, 115200,187500 *5 bps						RS-422/485, Asynchronous type, Data length : 7.8 bits, Parity : even, odd, none, Stop bit : 1.2 bits, Baud rate : 4800, 9600, 19200, 38400, 57600, 76800, 115200,187500 *5 bps	
	CF card interface	Optional unit DU-10						Compatible with CompactFlash™	
	Ethernet *3	Complies with IEEE802.3 Baud rate: 100Mbps, 10Mbps Cable: 100Ω Unsealed twist pair, Category 5, Max length: 100m						Complies with IEEE802.3 Not available	
	USB	Type A, Type B (Ver1.1)						Type B (Ver1.1)	
Clock & Back up memory	Battery	Coin-type lithium primary battery							
	Back up memory (SRAM)	512KB	128KB	512KB	128KB	512KB	128KB	512KB	128KB
	Back up period	5 years (Ambient temperature 25°C)							
Calendar accuracy	Gap±90 sec. per month (Ambient temperature 25°C)								

*3 Standard equipment only for V8i series

*4 When the panel surface luminance drops to 50% of the initial value at normal temperature (25°C)

*5 Available only when connected with SIEMENS MPI.

*6 Available only when an option unit [DU-10] is used for V806

Dimensions and Part Names

Provided with plentiful kinds of interfaces

V815iX / V815iXD

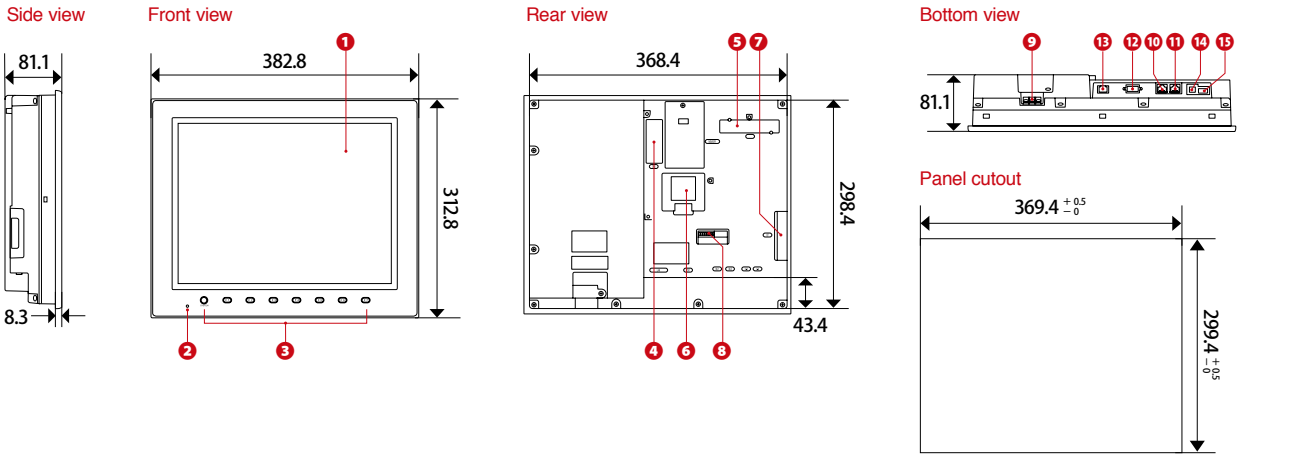

V812iS / V812S

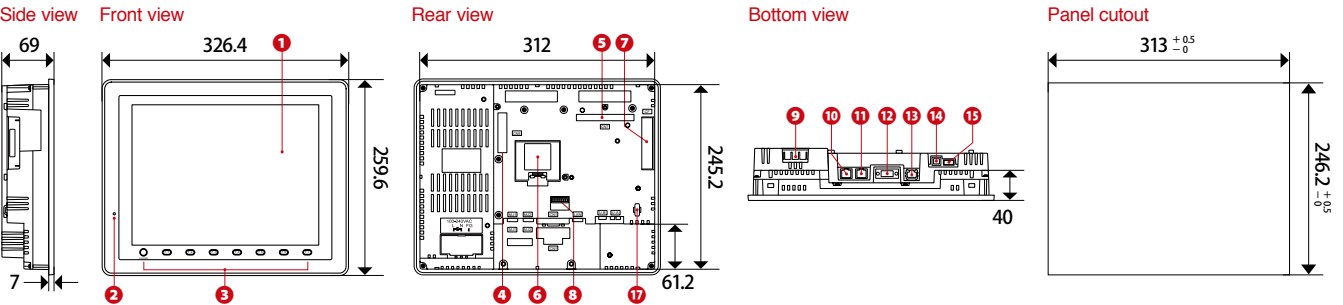

V810iS / V810S / V810iT / V810T / V810iC / V810C

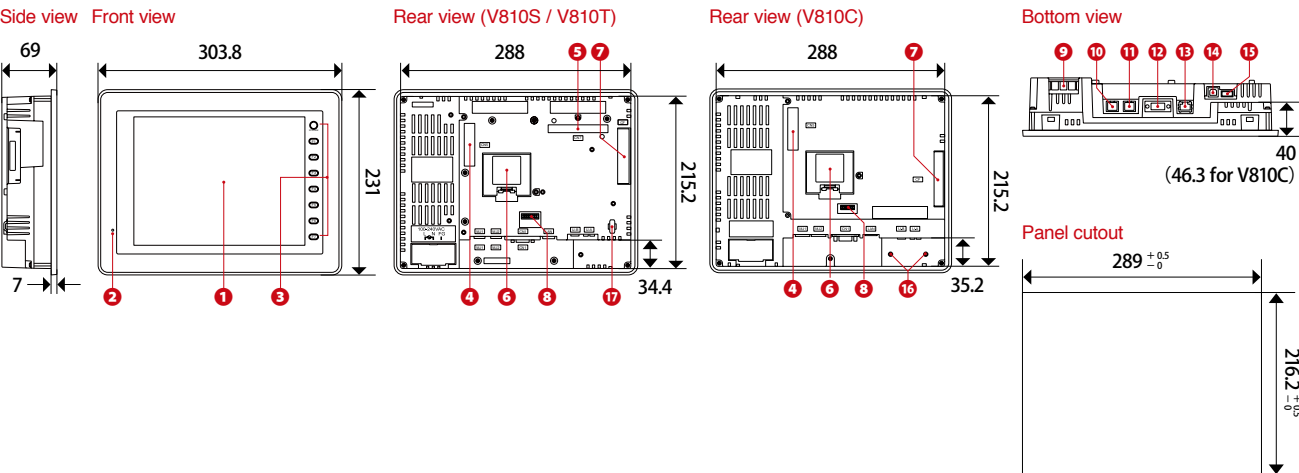

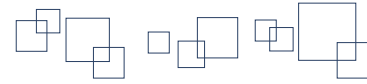

V808iS / V808S / V808iC / V808C

(mm)

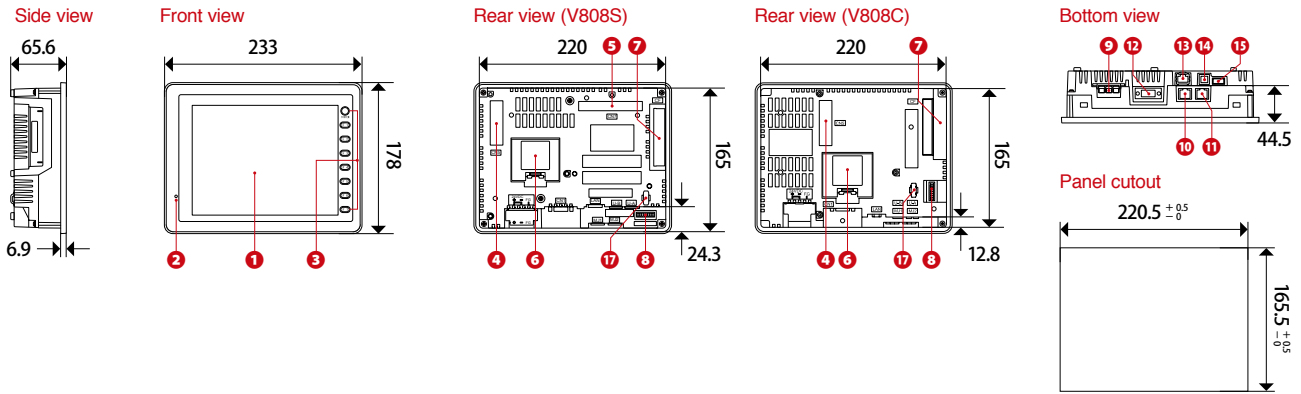

(mm)

V806iT / V806T / V806iC / V806C / V806iM / V806M

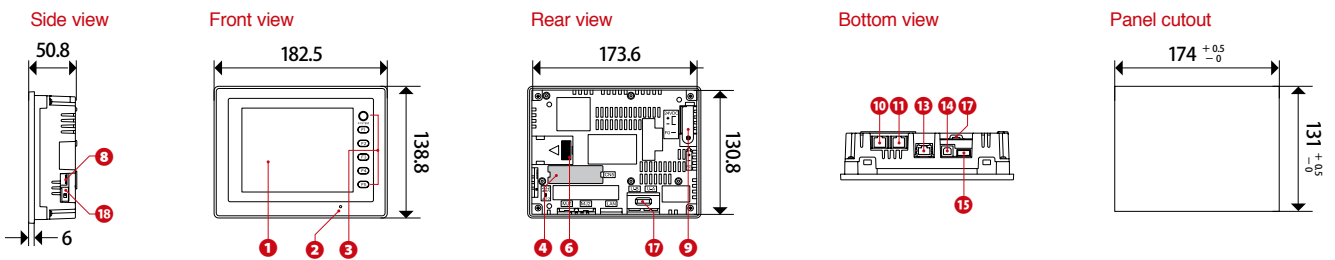

(mm)

V808iCH / V808CH

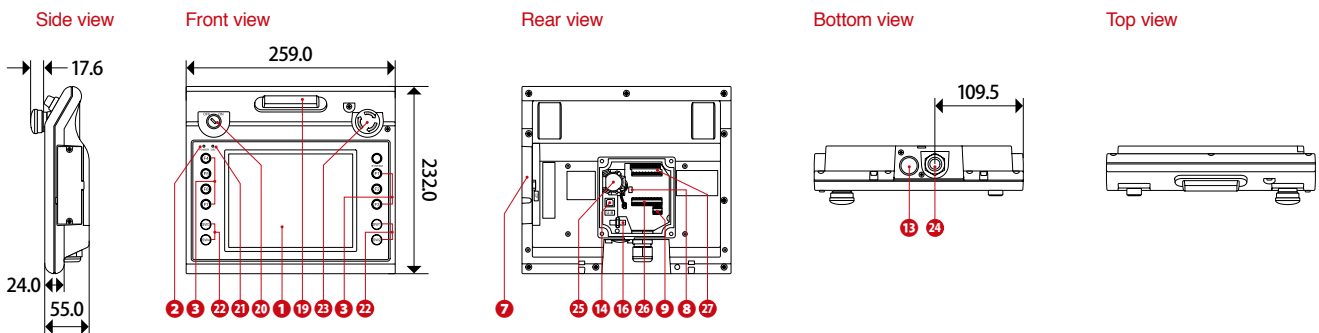

Part Names

- | | | | |
|--|--|------------------------------------|---------------------------|
| 1 Display | 8 DIP switch | 15 USB-A (master) | 21 OPERATION lamp |
| 2 Power lamp | 9 Power supply(TB1) | 16 Screw hole | 22 External output switch |
| 3 Function switch | 10 Modular 8-pin for serial port (MJ1) | for fixing USB cable lock | 23 Emergency stop switch |
| 4 Connector for communication unit (CN5) | 11 Modular 8-pin for serial port (MJ2) | 17 Inlet port for fixing USB cable | 24 Cable insertion slot |
| 5 Connector for optional unit (CN7) | 12 D-Sub 9-pin for serial port (CN1) | 18 Slide switch | 25 Battery |
| 6 Battery holder | 13 100BASE-TX/10BASE-T port (LAN) | 19 Deadman switch | 26 Terminal block (TB2) |
| 7 CF card slot (CF) | 14 USB-B (slave) | 20 Key switch | 27 Terminal block (TB3) |

Products
Display/Operation Features
Communication Features
Expandability
Usability
Configuration Software (V-SFT)
Component Parts
Expandability with MES/Ethernet
Specifications
Dimensions and Part Names
System Configuration
Option
Option List
Customer Service
Product Warranty

System Configuration

Flexible system configuration meets diversified requirements

V8i series V8iC series

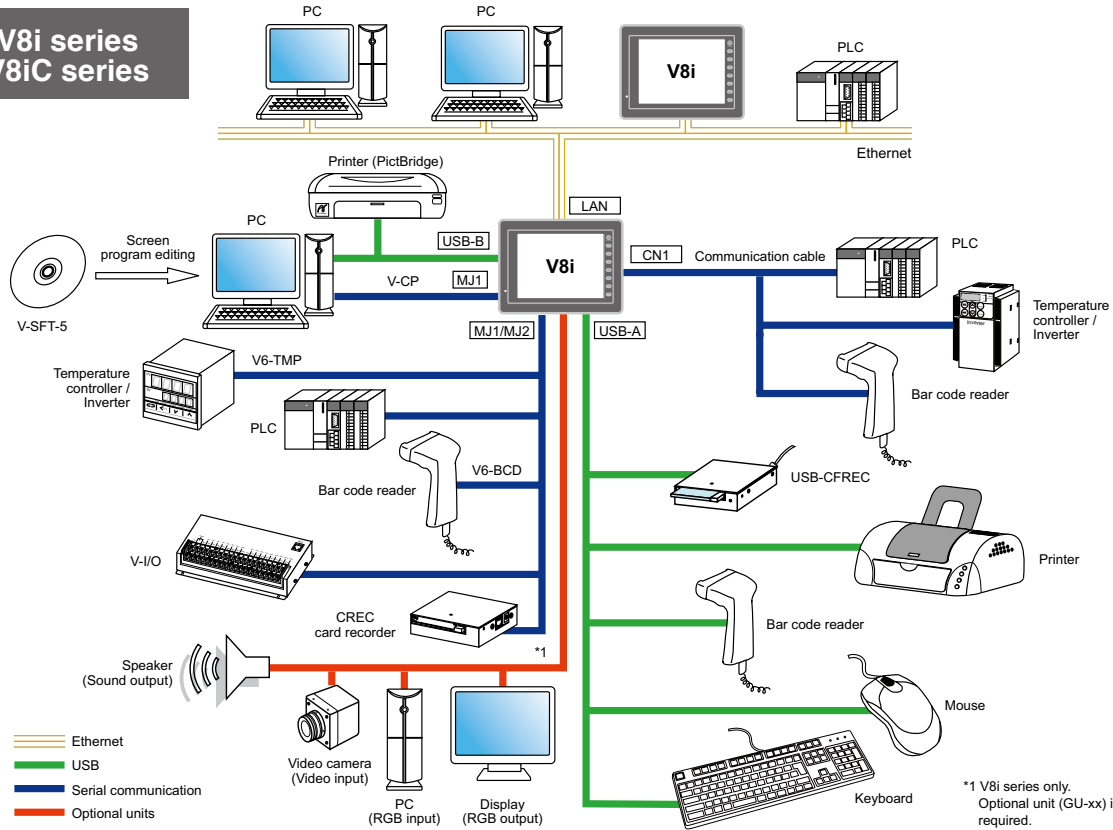

V8 series V8C series

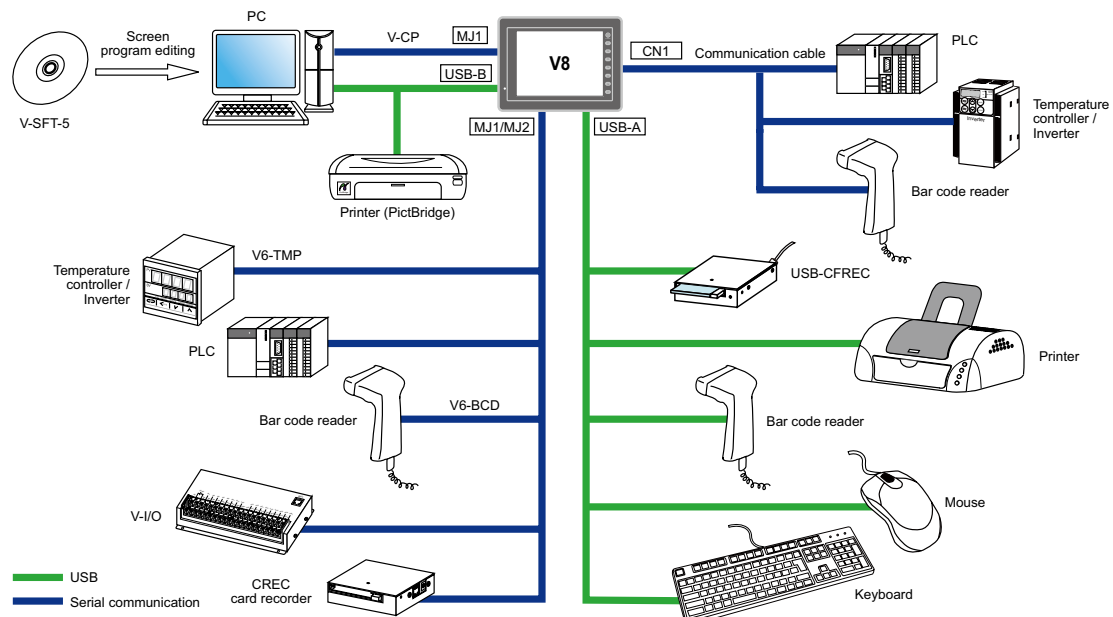



V806 + DU-10

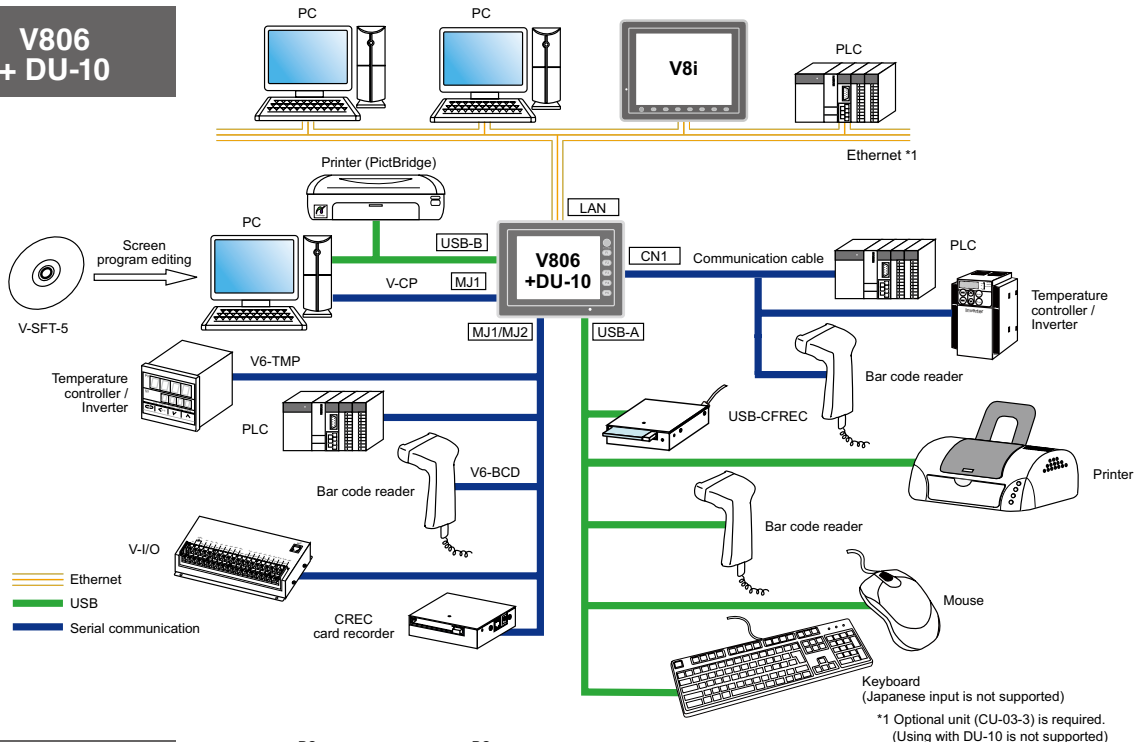

V806i

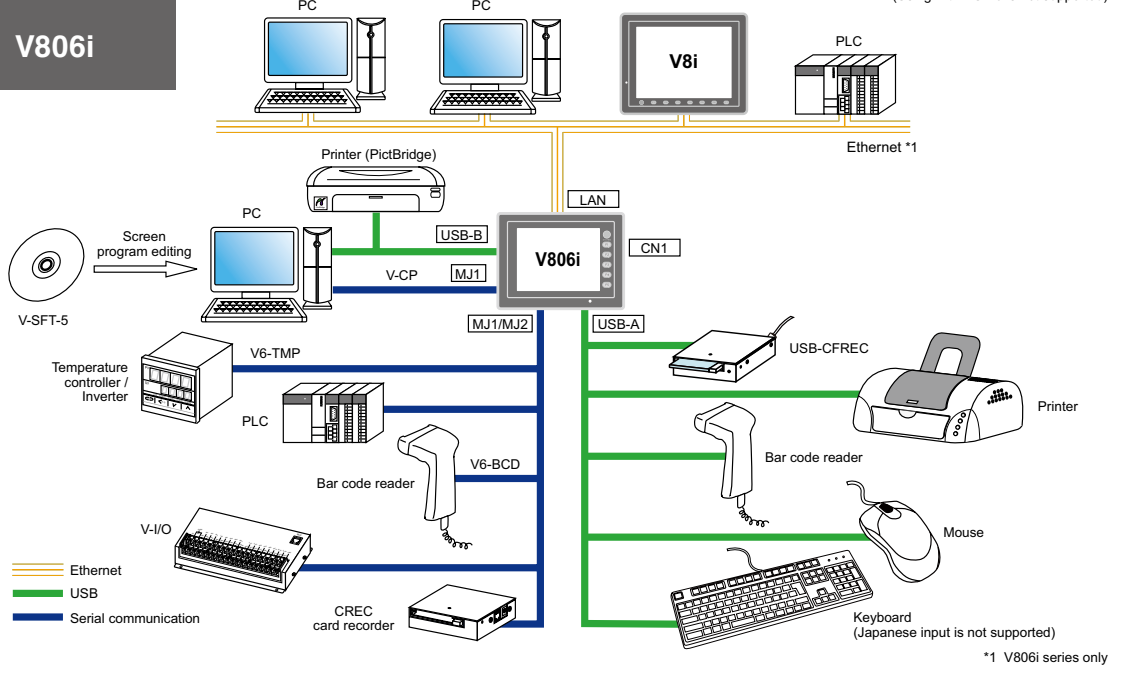

V808CH

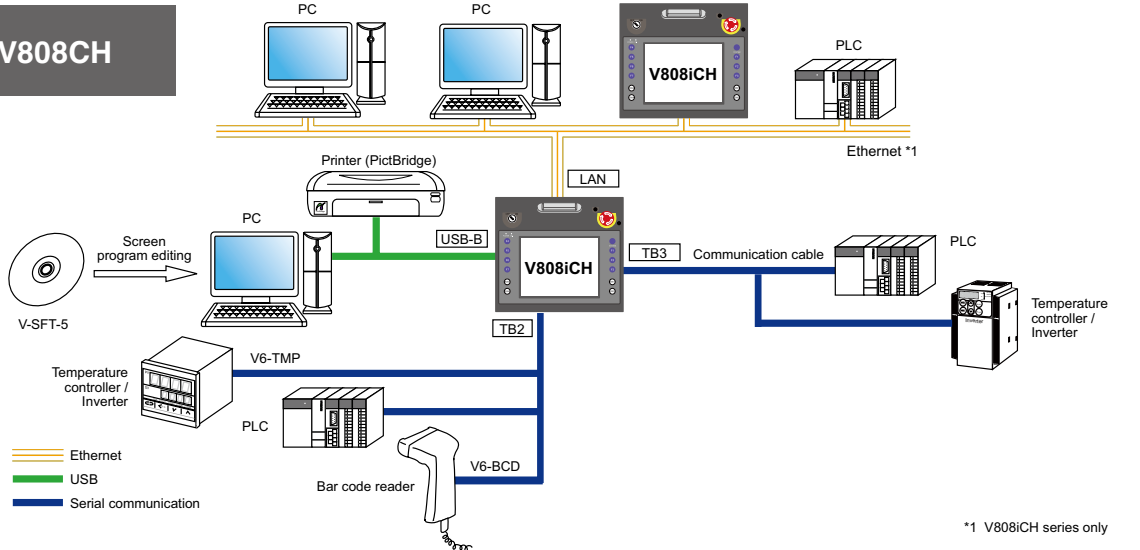

Products
Display/Operation Features
Communication Features
Expandability
Usability
Configuration Software (V-SFT)
Component Parts
Expandability with MES/Ethernet
Specifications
Dimensions and Part Names
System Configuration
Option
Option List
Customer Service
Product Warranty

Option Units

Optional units that expand V8's performance

Various units for greater expandability and usability

Expansion/ Communication Units

● Expansion units

GU-00(Video input + sound output unit)

Displays images from a video camera on V8 and outputs sound files through external speakers.



GU-01(RGB input + sound output unit)

Displays PC images on V8 and outputs sound files through external speakers.

GU-02(RGB output + sound output unit)

Displays images of V8 on PC display and outputs sound files through external speakers.

GU-03(Sound output unit)

Outputs sound files through external speakers.

GU-10(Video input(2ch) + RGB input)

Displays images from video cameras and PC images on V8 simultaneously.

GU-11(RGB input(2ch))

Displays RGB images such as PC images through two channels on V8 simultaneously.

DU-10(V806)

Compatible with a D-Sub9-pin/CF card.

● Communication units



XX	Compatible network	XX	Compatible network
00	OPCN-1	04	PROFIBUS-DP
01	T-Link	06	SX bus
02	CC-Link	07	DeviceNet ^{*1}
03-3	Ethernet	08	FL-net

Connected to various networks. Multiple V8 panels can be connected to one PLC. Other devices can be linked to the network, improving system's cost-effectiveness.

*1 Under development

Optional units



USB-CFREC (USB ports for CF card recorder)

Used for recording or reading data onto or from a CF card. Fitted on the front of the panel.



TC-D9 (Terminal converter)

Connects V8 with other units via RS-422/485 terminal.



CREC (Card recorder)

Used for recording data onto a card for back-up. Also used for recording data by memory manager or data logging functions.

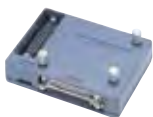

V-MDD (ACPU/QnACPU/FXCPU dual port interface)

Used to double the port of the connector for programmer units. Useful when connecting to ACPU/QnACPU/FXCPU(MITSUBISHI) directly.

Application Software

● Configuration software

V-SFT-5(Ver.5)

For Windows98/Me/NT Version4.0/2000/XP/XP 64 Edition/Vista 32bit



Cables

Type	Configuration	Connected to
V-CP	RS-232C Modular 8-pin D-Sub 9-pin Length: 3 m	PC
V6-BCD	RS-232C Modular 8-pin Length: 3 m	Bar code reader
V6-MLT	RS-422 Modular 8-pin Length: 3 m	MONITOUCH V8/V7/V6 series
V6-TMP	RS-232C/485 Modular 8-pin Length: 3, 5 or 10 m	Temperature controller and inverter etc.
UA-FR	Length: 1 m	USB-CFREC Card reader/writer
UB-FR	Length: 1 m	PC PictBridge Printer



V7-BT (Battery)

Lithium battery for V8 series



V8xx-GS/V8xx-GSN10

Protection sheet for panels: 5 sheets per set. N10 is a non-glare type sheet. See P37 for details.



V8xxx-FL

Backlight for V8. See P37 for details.



Panel Adapter

Used when fitting V8 into V4/GD-80/GD-65/GD-64 panel cutout.

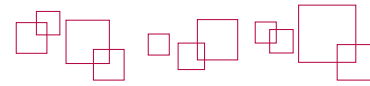

Option List

Optional units that expand V8's performance

Model	Description	Model																			
		V815			V812			V810					V808				V806				
		iX	iS	S	iS	S	iT	T	iC	C	iS	S	iC	C	iCH	CH	iT	T	iC	C	iM
Configuration software																					
V-SFT-5	Configuration software for V series (CD+Japanese manual set) ver.5	○	○	○	○	○	○	○	○	○	○	○	○	○	○	○	○	○	○	○	○
V-SFT-5(CD)	Configuration software for V series (Installation CD) ver.5	○	○	○	○	○	○	○	○	○	○	○	○	○	○	○	○	○	○	○	○
Communication units																					
CU-00	OPCN-1	○	○	○	○	○	○	○	○	○	○	○	○	○	○	○	○	○	○	○	○
CU-01	T-Link	○	○	○	○	○	○	○	○	○	○	○	○	○	○	○	○	○	○	○	○
CU-02	CC-Link	○	○	○	○	○	○	○	○	○	○	○	○	○	○	○	○	○	○	○	○
CU-03-3	Ethernet	○	○	○	○	○	○	○	○	○	○	○	○	○	○	○	○	○	○	○	○
CU-04	PROFIBUS-DP	○	○	○	○	○	○	○	○	○	○	○	○	○	○	○	○	○	○	○	○
CU-06	SX Bus	○	○	○	○	○	○	○	○	○	○	○	○	○	○	○	○	○	○	○	○
CU-08	FL-net Ver.2(OPCN-2)	○	○	○	○	○	○	○	○	○	○	○	○	○	○	○	○	○	○	○	○
Optional units																					
GU-00	VIDEO 4ch input, audio output	○	○	○	○	○	○	○	○	○	○	○	○	○	○	○	○	○	○	○	○
GU-01	RGB 1ch input, audio output	○	○	○	○	○	○	○	○	○	○	○	○	○	○	○	○	○	○	○	○
GU-02	RGB 1ch output, audio output	○	○	○	○	○	○	○	○	○	○	○	○	○	○	○	○	○	○	○	○
GU-03	audio output	○	○	○	○	○	○	○	○	○	○	○	○	○	○	○	○	○	○	○	○
GU-10	VIDEO 2ch input, RGB 1ch input	○	○	○	○	○	○	○	○	○	○	○	○	○	○	○	○	○	○	○	○
GU-11	RGB 2ch input	○	○	○	○	○	○	○	○	○	○	○	○	○	○	○	○	○	○	○	○
DU-10	Optional unit dedicated to V806 (Dsub9+CF card)															○	○	○	○	○	○
Cable																					
V-CP	Screen program transfer cable (3M)	○	○	○	○	○	○	○	○	○	○	○	○	○	○	○	○	○	○	○	○
UA-FR	USB-A panel surface fixing cable (1M)	○	○	○	○	○	○	○	○	○	○	○	○	○	○	○	○	○	○	○	○
UB-FR	USB-B panel surface fixing cable (1M)	○	○	○	○	○	○	○	○	○	○	○	○	○	○	○	○	○	○	○	○
V6-MLT	Multi-link 2 master cable (3M)	○	○	○	○	○	○	○	○	○	○	○	○	○	○	○	○	○	○	○	○
V6-TMP	Temperature controller connecting cable (3M)	○	○	○	○	○	○	○	○	○	○	○	○	○	○	○	○	○	○	○	○
MJ-D25	MJ-Dsub25 conversion cable	○	○	○	○	○	○	○	○	○	○	○	○	○	○	○	○	○	○	○	○
MJ2-PLC	MJ-Dsub25 conversion cable for V806 and V706	○	○	○	○	○	○	○	○	○	○	○	○	○	○	○	○	○	○	○	○
D9-MB-CPUQ	Mitsubishi Electric A series/QnA series CPU RS-422 (2,3,5,10,15M)	○	○	○	○	○	○	○	○	○	○	○	○	○	○	○	○	○	○	○	○
D9-QCPU2	Mitsubishi Electric Q series CPU RS-232C(2,3,5,10,15M)	○	○	○	○	○	○	○	○	○	○	○	○	○	○	○	○	○	○	○	○
D9-MI2-09	Mitsubishi Electric link unit RS-232C(2,3,5,10,15M)	○	○	○	○	○	○	○	○	○	○	○	○	○	○	○	○	○	○	○	○
D9-MI4-FX	Mitsubishi Electric FX series CPU RS-422(2,3,5,10,15M)	○	○	○	○	○	○	○	○	○	○	○	○	○	○	○	○	○	○	○	○
D9-FU-SPHCPU	Fuji Electric SPH CPU RS-485(4-wire) (2,3,5M)	○	○	○	○	○	○	○	○	○	○	○	○	○	○	○	○	○	○	○	○
D9-FU-SPBCPU	Fuji Electric SPB CPU RS-485(4-wire) (2,3,5M)	○	○	○	○	○	○	○	○	○	○	○	○	○	○	○	○	○	○	○	○
V706-ACPU	Mitsubishi Electric A series/QnA series CPU RS-422(2,3,5,10,15M)	○	○	○	○	○	○	○	○	○	○	○	○	○	○	○	○	○	○	○	○
MJ2-MI4FX	Mitsubishi Electric FX series CPU RS-422(2,3,5M)	○	○	○	○	○	○	○	○	○	○	○	○	○	○	○	○	○	○	○	○
MJ2-FU-SPHCPU	Fuji Electric SPH CPU RS-485(4-wire) (2,3,5M)	○	○	○	○	○	○	○	○	○	○	○	○	○	○	○	○	○	○	○	○
MJ2-FU-SPBCPU	Fuji Electric SPB CPU RS-485(4-wire) (2,3,5M)	○	○	○	○	○	○	○	○	○	○	○	○	○	○	○	○	○	○	○	○
V8H-C	External connection cable for V808CH (3,5,15,20M)														○	○					
D9-D25	Dsub9-Dsub25 conversion cable (0.3M)	○	○	○	○	○	○	○	○	○	○	○	○	○	○	○	○	○	○	○	○
Communication terminal block																					
TC-D9	Terminal converter for V8	○	○	○	○	○	○	○	○	○	○	○	○	○	○	○	○	○	○	○	○
Card recorder																					
USB-CFREC	USB CF card recorder	○	○	○	○	○	○	○	○	○	○	○	○	○	○	○	○	○	○	○	○
Dual port interface																					
V-MDD	Mitsubishi ACPUCPU/QnACPU/FXCPU port interface	○	○	○	○	○	○	○	○	○	○	○	○	○	○	○	○	○	○	○	○
I/O unit																					
V-I/O	Expanded serial I/O unit	○	○	○	○	○	○	○	○	○	○	○	○	○	○	○	○	○	○	○	○
Battery																					
V7-BT	Battery for V8, V7 and V606e	○	○	○	○	○	○	○	○	○	○	○	○	○	○	○	○	○	○	○	○
Switch guard cover																					
V8H-SWG	Switch guard														○	○					
Wall-hanging clasp																					
V6H-WF	Wall-hanging clasp set (For V808CH/V608CH)														○	○					
V6H-WF1	Wall-hanging bracket (wall side) (For V808CH/V608CH)														○	○					
V8H-WFV	Fitting for V808CH (VESA-compliant)														○	○					
Protection sheet																					
V806-GS	Surface protection sheet for V806																○	○	○	○	○
V806-GSN10	Surface protection sheet for V806 (nonglare)																○	○	○	○	○
V808-GS	Surface protection sheet for V808											○	○	○	○						
V808-GSN10	Surface protection sheet for V808 (nonglare)											○	○	○	○						
V810-GS	Surface protection sheet for V810					○	○	○	○	○	○										
V810-GSN10	Surface protection sheet for V810 (nonglare)					○	○	○	○	○	○										
V812-GS	Surface protection sheet for V812			○	○																
V812-GSN10	Surface protection sheet for V812 (nonglare)			○	○																
V715-GS	Surface protection sheet for V815/V715	○																			
V715-GSN10	Surface protection sheet for V815/V715 (nonglare)	○																			
Backlight																					
V808C-FL	Backlight for V808C series												○	○							
V808S-FL	Backlight for V808S series												○	○							
V810-FL	Backlight for V810S/T series					○	○	○	○	○	○										
V812-FL	Backlight for V812S series			○	○																
V715-FL	Backlight for V815IX series	○																			

*1 The optional unit: DU-10 is required.
 *2 Used both MJ1/MJ2 ports.

Products
Display/Operation Features
Communication Features
Expandability
Usability
Configuration Software (V-SFT)
Component Parts
Expandability with MCS/Ethernet
Specifications
Dimensions and Part Names
System Configuration
Option
Option List
Customer Service
Product Warranty

Customer Service

Global service network

Please contact our customer service department for information and advice.

TEL

Tel +81-76-274-2144

FAX

Fax +81-76-274-5208

E-mail

sales@hakko-elec.co.jp

Website

<http://www.monitouch.com>

Includes FAQs for troubleshooting, instruction manuals, sample screens, and information for upgrading of configuration software.

<http://www.monitouchv8.com>

MONITOUCH V8 series
Visit our website for MONITOUCH V8 Series.



Global Sales Network

Our distributors are ready to support your worldwide business.

<http://www.hakko-elec.co.jp/en/distributors/index.html>

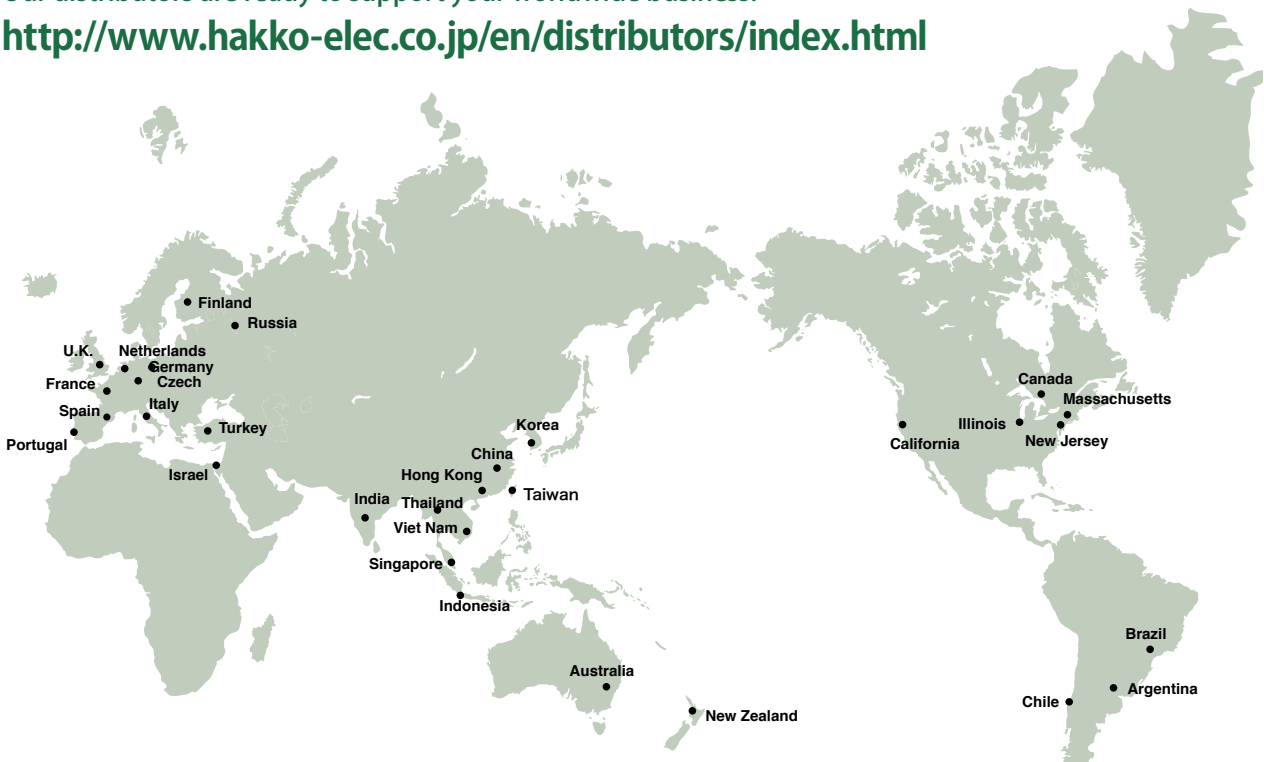



Product Warranty

To the purchasers of Hakko Electronics products:

The warranty of this product is as follows, unless there are special instructions that state otherwise in the quote, contract, catalog, or specifications at the time of the quote or order.

The purpose or area of use may be limited, and a routine checkup may be required depending on the product. Please contact the distributor from which you purchased the product, or Hakko Electronics for further information.

Please conduct inspection of the product promptly upon purchase or delivery. Also, please give sufficient consideration to management and maintenance of the product prior to accepting it.

1. Period and Coverage of the Warranty

1-1 Period

- (1) The period of the warranty is effective until twenty-four (24) months from the date of manufacture printed on the plate.
- (2) The above period may not be applicable if the particular environment, conditions or frequency of use affects the lifetime of the product.
- (3) The warranty for the parts repaired by Hakko Electronics' service department is effective for six (6) months from the date of repair.

1-2 Coverage

- (1) If malfunction occurs during the period of warranty due to negligence on the part of Hakko Electronics, the malfunctioning parts are exchanged or repaired free of charge at the point of purchase or delivery. However, the warranty does not apply to the following cases:
 - 1) The malfunction occurs due to inappropriate conditions, environment, handling or usage that is not specified in the catalog, instruction book or users' manual.
 - 2) The malfunction is caused by factors that do not originate in the purchased or delivered product.
 - 3) The malfunction is caused by another device or software design that does not originate in a Hakko Electronics product.
 - 4) The malfunction occurs due to an alteration or repair that was not performed by Hakko Electronics.
 - 5) The malfunction occurs because the expendable parts listed in the instruction book or catalog were not maintained or replaced in an appropriate manner.
 - 6) The malfunction occurs due to factors that were not foreseeable by the practical application of science and technology at the time of purchase or delivery.
 - 7) The malfunction occurs because the product is used for a purpose other than that for which it is intended.
 - 8) The malfunction occurs due to a disaster or natural disaster that Hakko Electronics is not responsible for.
- (2) The warranty is only applicable to the single purchased and delivered product.
- (3) The warranty is only valid for the conditions stated in (1) above. Any damage induced by the malfunction of the purchased or delivered product, including damage or loss to a device or machine and passive damage, is not covered by the warranty.

1-3 Malfunction Diagnosis

The initial diagnosis of malfunction is to be made by the purchaser. The diagnosis can be conducted by Hakko Electronics or its delegated service provider with due charge upon the request of the purchaser. The charge is to be paid by the purchaser at the rate stipulated in the rate schedule of Hakko Electronics.

2. Liability for Opportunity Loss

Regardless of the time of occurrence, Hakko Electronics is not liable for damage caused by factors that Hakko Electronics is not responsible for, opportunity loss on the part of the purchaser caused by the malfunction of a Hakko Electronics product, passive damage, damage due to a special situation regardless of whether it was foreseeable or not, or secondary damage, accident compensation, damage to products that were not manufactured by Hakko Electronics, or compensation towards other operations.

3. Period for Repair and Provision of Spare Parts after Production is Discontinued (Maintenance Period)

Discontinued models (products) can be repaired for seven (7) years from the date of discontinuation. Also, most spare parts used for repair are provided for seven (7) years from the date of discontinuation. However, some electric parts may not be available due to their short life cycle. In this case, it may be difficult to repair or provide the parts during the seven-year period. Please contact Hakko Electronics or its service providers for further information.

4. Delivery

Standard products that do not entail application setting or adjustment are regarded as received by the purchaser upon delivery. Hakko Electronics is not responsible for local adjustments and test runs.

5. Service

The price of the delivered or purchased products does not include the service fee for the technician. Please contact Hakko Electronics or its service providers for further information.

6. Scope of Application

The above contents shall be assumed to apply to transactions and product use in the country where a Hakko Electronics product is purchased. Please consult your local supplier or Hakko Electronics for details.

Products
Display/Operation Features
Communication Features
Expandability
Usability
Configuration Software (V-SFT)
Component Parts
Expandability with MES/Ethernet
Specifications
Dimensions and Part Names
System Configuration
Option
Option List
Customer Service
Product Warranty

Safety Considerations

- For safe operation, read the instruction manual or user manual that comes with the product carefully or consult the distributor from which you purchased the product, before using the product.
- Products introduced in this catalog have not been designed or manufactured for such applications in a system or equipment that will affect human bodies or lives.
- Customers, who want to use the products introduced in this catalog for special systems or devices such as for atomic-energy control, aerospace use, medical use, passenger vehicle, and traffic control, are requested to consult the Hakko Overseas Sales Section.
- Customers are requested to prepare safety measures when they apply the products introduced in this catalog to such systems or facilities that will affect human lives or cause severe damage to property if the products become faulty.
- For safe operation, wiring should be conducted only by qualified engineers who have sufficient technical knowledge about electrical work or wiring.

Notes to consider before purchasing

- Appearance and specifications are subject to modification without prior notice due to technical improvements.
- Colors in the catalog may differ from the actual colors due to printing inaccuracies.
- Consult your distributor or us for further information about products in this catalog.

www.monitouch.com

Hakko Electronics Co., Ltd.

Overseas Sales Department
890-1 Kamikashiwano-machi,
Hakusan, Ishikawa 924-0035, Japan

- Tel
+81-76-274-2144
- Fax
+81-76-274-5208
- E-mail
sales@hakko-elec.co.jp

Distributor

- * Product specifications and design are subject to modification.
- * Combined images are used for the screen images.
- * Product colors may differ from colors in brochure photos due to printing.
- * Windows and Excel are trademarks of Microsoft (USA) in the U.S. and other countries.
- * Other company and product names in this brochure are registered trademarks.
- * Printed with environment-friendly soy ink.

