



GLOBAL TWIN SERIES

UL 489 LISTED

MOLDED CASE CIRCUIT BREAKERS
EARTH LEAKAGE CIRCUIT BREAKERS



50A Frame ~ 800A Frame | Max Voltage 600V

The new FUJI UL489 Molded Case Circuit Breaker and Earth Leakage Circuit Breaker (GLOBAL TWIN series) provide the ultimate in compact design, unprecedented value, and use anywhere in the world.



50A Frame



125A Frame



250A Frame



400A Frame



- MORE COMPACT (especially 50/100A Frame, 125A Frame, 250A Frame) than any breaker on the market, so control panels take up less space than ever before.
- Competitive pricing.
- Conformity to all WORLDWIDE STANDARDS, including UL / CSA / IEC / CE Marking / JIS (Japan) / CCC (China).



Fuji's GLOBAL TWIN series gives you the features and flexibility you need:

- 1) Suitable for branch circuit protection.
- 2) Rated current of 3-800A, Max 600V.
- 3) Standard type and High interrupting capacities are available in identically sized breakers.
- 4) Shunt trip (F), Under voltage release (R) and other accessories are available.
- 5) Screw, Flat, or Lug terminal are available.
- 6) Auxiliary switch, Alarm switch, and Shunt trip can be installed in the field.
- 7) Choose Breaker-Mounted (N type) or Panel Door-Mounted (V type), Flange-Mounted (F type), operating handles.

Table of Contents

	Page
Specifications for MCCB	3
Specifications for ELCB	7
Part Number Structure	10
Characteristic Curves	11
Dimensions	14
Internal Accessories	20
External Accessories	27
Dimensions of Operating Handles	29
Wiring, Wire Sizes and Tightening Torque	33
Flange Disconnect Handle	34
Discontinued Products Cross Chart	37
Terms & Conditions	42

Molded Case Circuit Breakers - New G-Twin, UL489 Listed BW Series

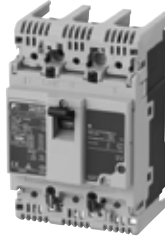
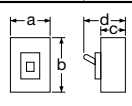
Frame size (A)		50		100		
Type		BW50RAGU-2P		BW50RAGU-3P		
Appearance (with Screw Terminals, 3 poles)						
SCCR=UL489 interrupting capacity						
Rated insulation voltage (V) (IEC60947-2)		AC 690 DC -		690 -		
Rated voltage (V) (UL489)		AC 240		240		
Rated current (A)		3,5 10,15,20,30,32,40,50		3,5 10,15,20,30,32,40,50		
Poles		2		3		
Rated frequency (Hz)		50/60		50/60		
Rated interrupting capacity sym (kA)	UL489 CAN/CSA C22.2 No.5	AC	600V/Δ	-	-	-
			600V/Y	-	-	-
			480V/Δ	-	-	-
			480V/Y	-	-	-
		240V	14	14	14	
	DC	250V	-	-	-	
	IEC60947-2 JIS C 8201-2-1 lcu/lcs	AC	690V	-	-	-
			600V	5/3	5/3	5/3
			500V	7.5/4	7.5/4	7.5/4
			440V	10/5	10/5	10/5
			400V	10/5	10/5	10/5
			230V	25/13	25/13	25/13
		DC	250V	5/3	5/3	5/3
	GB14048.2 lcu/lcs	AC	400V	7/4 10/5	7/4 10/5	10/5
			230V	14/7 25/13	14/7 25/13	25/13
Dimension inch (mm)			a	1.969(50)	2.953(75)	1.969(50)
			b	4.724(120)	4.724(120)	4.724(120)
			c	2.362(60)	2.362(60)	2.362(60)
			d	3.307(84)	3.307(84)	3.307(84)
Terminal construction	Screw terminals	None	●	●	●	
	Flat terminals	SF	●	●	●	
	Lug terminals	SB	-	-	●	
Internal accessories *4	Auxiliary switch	W	BZ6WR10CU	BZ6W*10CU	BZ6WR10CU	
	Auxiliary switch for low current	WD	BZ6WDR10CU	BZ6WD*10CU	BZ6WDR10CU	
	Alarm switch	K	BZ6KR10CU	BZ6K*10CU	BZ6KR10CU	
	Alarm switch for low current	KD	BZ6KDR10CU	BZ6KD*10CU	BZ6KDR10CU	
	Auxiliary & Alarm switch	WK	BZ6WKR10CU	BZ6WK*10CU	BZ6WKR10CU	
	Aux and Alarm for low current	WDKD	BZ6WDKDR10CU	BZ6WDKD*10CU	BZ6WDKDR10CU	
	Shunt trip	F	BZ6F*10CU	BZ6F*10CU	BZ6F*10CU	
	Under voltage trip	R	BZ6R*10CAU	BZ6R*10CU	BZ6R*10CAU	
Accessories with terminal block	A	*1	*1	*1		
External accessories	Padlocking device (Cap type)*5	Q1	BZ6L10CA	BZ6L10CA	BZ6L10CA	
	Handle locking cover *5		BZ6L10C	BZ6L10C	BZ6L10C	
	External operating handle	V	BZ6V10D	BZ6V10D	BZ6V10D	
		N	BZ6N10D	BZ6N10D	BZ6N10D	
	Field Installable terminal Kit	Flat terminal kit	BZ-SU20B	BZ-SU20B	BZ-SU25B	
		Lug terminal kit	-	-	-	
	Terminal covers *3	for screw, short type	Provided	Provided	Provided	
		for screw, long type	BW9BTAA-L2W	BW9BTAA-L3W	BW9BTAA-L3W	
		for Flat terminal	-	-	-	
		for Lug terminal	-	-	-	
Insulation barrier *2		BZ6B10C	BZ6B10C	BZ6B10C		
Mass: lb. (kg) (screw terminals)		0.88(0.4)	1.10(0.5)	0.88(0.4)	1.10(0.5)	

*1 For internal accessories with terminal block, specify "A" in the accessory P/N. When 50A Frame & 100A Frame are ordered w/UVT, the UVT is supplied with terminal block as standard.

*2 Insulation barriers are only required with flat terminal.



*3 Short terminal covers are supplied as standard. If long terminal covers are required, please order BW9BTAA-L2W or BW9BTAA-L3W.

*4 These internal accessories can be installed in the field. (see page 20 for part number)

*5 Non-UL item

●: Available, -: Not available

Molded Case Circuit Breakers - New G-Twin, UL489 Listed BW Series

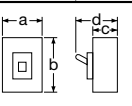
Frame size (A)		125				250					
Type		BW125JAGU		BW125RAGU		BW250EAGU		BW250JAGU		BW250RAGU	
Appearance (with Screw Terminals, 3 poles)											
SCCR=UL489 interrupting capacity											
Rated insulation voltage (V) (IEC60947-2)		AC 690 DC 250		690 250		690 250		690 250		690 250	
Rated voltage (V) (UL489)		AC 600Y/347		600Y/347		240		600Y/347		600Y/347	
Rated current (A)		15,20,30,40,50,60,70,75,80,90,100,125				125,150,160,175,200,225,250					
Poles		2 3		2 3		2 3		2 3		2 3	
Rated frequency (Hz)		50/60		50/60		50/60		50/60		50/60	
Rated interrupting capacity sym (kA)	UL489 CAN/CSA C22.2 No.5	AC	600V/Δ	-	-	-	-	-	-	-	-
			600V/Y	10	10	18	-	10	25		
			480V/Δ	-	30	50	-	30	50		
			480V/Y	30	30	50	-	30	50		
			240V	50	50	100	22	50	100		
	IEC60947-2 JIS C 8201-2-1 Icu/Ics	AC	690V	-	5/3	-	-	5/3			
			500V	15/8	36/18	10/5	18/9	36/18			
			440V	30/15	50/25	18/9	30/15	50/25			
			400V	30/15	50/25	18/9	30/15	50/25			
			380V	30/15	50/25	18/9	30/15	50/25			
	GB14048.2 Icu/Ics	AC	240V	50/25	100/50	36/18	50/25	100/50			
			250V	15/8	40/20	10/5	20/10	40/20			
400V			30/15	50/25	18/9	30/15	50/25				
230V			50/25	100/50	36/18	50/25	100/50				
Dimension inch (mm)					a	2.362(60) 3.543(90)	3.543(90)	4.134(105)	4.134(105)	4.134(105)	
Terminal construction	Screw terminals (standard)	None	●	●	●	●	●				
	Flat terminals	SF	●	●	●	●	●				
	Lug terminals	SB	●	●	●	●	●				
Internal accessories	Auxiliary switch	W	BW9W1SG0(-R)	BW9W1SG0(-R)	BW9W1SG0(-R)	BW9W1SG0(-R)	BW9W1SG0(-R)				
	Auxiliary switch for low current	1	BW9W1DG0(-R)	BW9W1DG0(-R)	BW9W1DG0(-R)	BW9W1DG0(-R)	BW9W1DG0(-R)				
	Alarm switch	K	BW9K1SG0(-R)	BW9K1SG0(-R)	BW9K1SG0(-R)	BW9K1SG0(-R)	BW9K1SG0(-R)				
	Alarm switch for low current	8	BW9K1DG0(-R)	BW9K1DG0(-R)	BW9K1DG0(-R)	BW9K1DG0(-R)	BW9K1DG0(-R)				
	Auxiliary & Alarm switch	WK	BW9WKSG0(-R)	BW9WKSG0(-R)	BW9WKSG0(-R)	BW9WKSG0(-R)	BW9WKSG0(-R)				
	Aux & Alarm for low current	18	BW9WKDG0(-R)	BW9WKDG0(-R)	BW9WKDG0(-R)	BW9WKDG0(-R)	BW9WKDG0(-R)				
	Shunt trip	F	BW9F*G0	BW9F*G0	BW9F*G0	BW9F*G0	BW9F*G0				
	Under voltage trip	R	-	BW9RGA*	BW9RGA*	BW9RGA*	BW9RGA*				
	Accessories with terminal block	A	See page 22		See page 22		See page 22				
External accessories	Padlocking device *2	Q1	BW9Q1CA	BW9Q1CA	BW9Q1CA	BW9Q1CA	BW9Q1CA				
		Q2	BW9Q2CA	BW9Q2CA	BW9Q2GA	BW9Q2GA	BW9Q2GA				
	External operating handle	V	-	BW9V0CA	BW9V0CA	BW9V0GA	BW9V0GA				
		N	-	BW9N0CA	BW9N0CA	BW9N0GA	BW9N0GA				
		F	-	BW9F0CA	BW9F0CA	BW9F0GA	BW9F0GA				
	Field Installable terminal kit	Flat terminal kit	BZ-S50B-2253 GLOBAL				BW9SS0CA-3 GLOBAL				
		Lug terminal kit	BW9SL0CA-3 GLOBAL				Please see page 28.				
	Terminal covers *1	Short type,gray-white	Provided		Provided	Provided	Provided	Provided			
		Short type,transparent	BW9BTCA-S2	BW9BTCA-S3	BW9BTCA-S3	BW9BTGA-S3	BW9BTGA-S3	BW9BTGA-S3			
		Long type,gray-white	BW9BTCA-L2W	BW9BTCA-L3W	BW9BTCA-L3W	BW9BTGA-L3W	BW9BTGA-L3W	BW9BTGA-L3W			
Long type,transparent		BW9BTCA-L2	BW9BTCA-L3	BW9BTGA-L3	BW9BTGA-L3	BW9BTGA-L3	BW9BTGA-L3				
Insulation barrier	BW9BPCA		BW9BPCA	BW9BPGA	BW9BPGA	BW9BPGA					
Mass: lb. (kg) (screw terminals)	1.76(0.8)	2.65(1.2)	2.20(1.0)	2.65(1.2)	3.09(1.4)	3.53(1.6)	3.09(1.4)	3.53(1.6)	3.09(1.4)	3.53(1.6)	

*1 Short type terminal covers (gray-white) are supplied as standard.

*2 Non-UL item

●: Available, -: Not available

Molded Case Circuit Breakers - New G-Twin, UL489 Listed BW Series

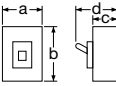
Frame size (A)		400							
Type		BW400EAGU		BW400SAGU		BW400RAGU		BW400HAGU	
Appearance (with Flat Terminals, 3 poles)									
SCCR=UL489 interrupting capacity									
Rated insulation voltage (V) (IEC60947-2)		AC	690	690	690	690	690	690	690
		DC	250	250	250	250	250	250	250
Rated voltage (V) (UL489)		AC	240	480	480	480	480	600	600
Rated current (A)		250, 300, 350, 400							
Poles		2		3		2		3	
Rated frequency (Hz)		50/60		50/60		50/60		50/60	
Rated interrupting capacity sym (kA)	UL489 CAN/CSA C22.2 No.5	AC	600V/Δ	–	–	–	–	25	25
			600V/Y	–	–	–	–	25	25
			480V/Δ	–	35	35	50	65 (50: with lug terminals)	65 (50: with lug terminals)
		480V/Y	–	35	35	50	65 (50: with lug terminals)	65 (50: with lug terminals)	
		240V	22	50	50	100	125	125	
		DC	250V	10	10	10	10	10	
	IEC60947-2 JIS C 8201-2-1 Icu/Ics	AC	690V	–	10/5	15/8	15/8	15/8	
			500V	18/9	20/11	36/18	42/21	42/21	
			440V	30/15	36/18	50/25	70/35	70/35	
		400V	30/15	36/18	50/25	70/35	70/35		
		380V	30/15	36/18	50/25	70/35	70/35		
		240V	50/25	85/43	100/50	125/63	125/63		
DC	250V	20/10	20/10	40/20	40/20	40/20			
GB14048.2 Icu/Ics	AC	400V	30/15	36/18	50/25	70/35	70/35		
		230V	50/25	85/43	100/50	125/63	125/63		
Dimension inch (mm)		a	5.512(140)	5.512(140)	5.512(140)	5.512(140)	5.512(140)		
		b	10.12(257)	10.12(257)	10.12(257)	10.12(257)	10.12(257)		
		c	4.055(103)	4.055(103)	4.055(103)	4.055(103)	4.055(103)		
		d	5.748(146)	5.748(146)	5.748(146)	5.748(146)	5.748(146)		
Terminal construction	Screw terminals	–	–	–	–	–	–		
	Flat terminals (standard)	None	●	●	●	●	●		
	Lug terminals	SB	●	●	●	●	●		
Internal accessories	Auxiliary switch	W	BW9W1SHA	BW9W1SHA	BW9W1SHA	BW9W1SHA	BW9W1SHA		
	Auxiliary switch 2 contacts	V	BW9W2SHA	BW9W2SHA	BW9W2SHA	BW9W2SHA			
	Aux. low current	1	BW9W1DHA	BW9W1DHA	BW9W1DHA	BW9W1DHA			
	Aux. low current 2 contacts	2	BW9W2DHA	BW9W2DHA	BW9W2DHA	BW9W2DHA			
	Alarm switch	K	BW9K1SHA	BW9K1SHA	BW9K1SHA	BW9K1SHA			
	Alarm switch 2 contacts	J	BW9K2SHA	BW9K2SHA	BW9K2SHA	BW9K2SHA			
	Alarm low current	8	BW9K1DHA	BW9K1DHA	BW9K1DHA	BW9K1DHA			
	Alarm low current 2 contacts	9	BW9K2DHA	BW9K2DHA	BW9K2DHA	BW9K2DHA			
	Shunt trip	F	BW9FHA-*	BW9FHA-*	BW9FHA-*	BW9FHA-*			
	Under voltage trip	R	BW9RHA-*	BW9RHA-*	BW9RHA-*	BW9RHA-*			
Accessories with terminal block	A	See page 22	See page 22	See page 22	See page 22	See page 22			
External accessories	Padlocking device *2	QN	BW9QNHA	BW9QNHA	BW9QNHA	BW9QNHA			
		Q2	BW9Q2HA	BW9Q2HA	BW9Q2HA	BW9Q2HA			
	External operating handle	V	BW9V0HA	BW9V0HA	BW9V0HA	BW9V0HA			
		N	BW9N0HA	BW9N0HA	BW9N0HA	BW9N0HA			
		F	BW9F0HA	BW9F0HA	BW9F0HA	BW9F0HA			
	Field Installable terminal	–	–	–	–	–			
	Terminal covers *1	Insulation barrier	Short type, gray-white	BW9BTHA-S3W	BW9BTHA-S3W	BW9BTHA-S3W	BW9BTHA-S3W		
			Short type, transparent	BW9BTHA-S3	BW9BTHA-S3	BW9BTHA-S3	BW9BTHA-S3		
			Long type, gray-white	BW9BTHA-L3W	BW9BTHA-L3W	BW9BTHA-L3W	BW9BTHA-L3W		
			Long type, transparent	BW9BTHA-L3	BW9BTHA-L3	BW9BTHA-L3	BW9BTHA-L3		
Insulation barrier		B-43A	B-43A	B-43A	B-43A	B-43A			
Mass: lb. (kg) (screw terminals)		10.14(4.6)	12.35(5.6)	10.14(4.6)	12.35(5.6)	10.14(4.6)	12.35(5.6)		

*1 Terminal covers are NOT supplied as standard.

*2 Non-UL item

●: Available, -: Not available

Molded Case Circuit Breakers - New G-Twin, UL489 Listed BW Series

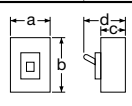
Frame size (A)		630		800			
Type		BW630RAGU	BW630HAGU	BW800RAGU	BW800HAGU		
Appearance (with Flat Terminals, 3 poles)							
SCCR=UL489 interrupting capacity							
Rated insulation voltage (V) (IEC60947-2)		AC 690 DC 250	690 250	690 250	690 250		
Rated voltage (V) (UL489)		AC 480	600	480	600		
Rated current (A)		500, 600, 630		700, 800			
Poles		3	3	3	3		
Rated frequency (Hz)		50/60		50/60			
Rated interrupting capacity sym (kA)	UL489 CAN/CSA C22.2 No.5	AC	600V/Δ	–	25	–	25
			600V/Y	–	25	–	25
			480V/Δ	50	65 (50: with lug terminals)	50	65 (50: with lug terminals)
			480V/Y	50	65 (50: with lug terminals)	50	65 (50: with lug terminals)
			240V	100	100	100	125
	IEC60947-2 JIS C 8201-2-1 Icu/Ics	AC	690V	15/8	15/8	15/8	15/8
			500V	36/18	42/21	36/18	42/21
			440V	50/25	70/35	50/25	70/35
			400V	50/25	70/35	50/25	70/35
			380V	50/25	70/35	50/25	70/35
	GB14048.2 Icu/Ics	AC	240V	100/50	125/63	100/50	125/63
			250V	40/20	40/20	40/20	40/20
			400V	50/25	70/35	50/25	70/35
			230V	100/50	125/63	100/50	125/63
Dimension inch (mm)		a	8.268(210)	8.268(210)	8.268(210)	8.268(210)	
		b	10.83(275)	10.83(275)	10.83(275)	10.83(275)	
		c	4.055(103)	4.055(103)	4.055(103)	4.055(103)	
		d	5.748(146)	5.748(146)	5.748(146)	5.748(146)	
Terminal construction	Screw terminals	–	–	–	–		
	Flat terminals	None	●	●	● *2		
	Lug terminals	SB	● *1	● *1	●		
Internal accessories	Auxiliary switch	W	BW9W1SHA	BW9W1SHA	BW9W1SHA	BW9W1SHA	
	Auxiliary switch 2 contacts	V	BW9W2SHA	BW9W2SHA	BW9W2SHA	BW9W2SHA	
	Aux. low current	1	BW9W1DHA	BW9W1DHA	BW9W1DHA	BW9W1DHA	
	Aux. low current 2 contacts	2	BW9W2DHA	BW9W2DHA	BW9W2DHA	BW9W2DHA	
	Alarm switch	K	BW9K1SHA	BW9K1SHA	BW9K1SHA	BW9K1SHA	
	Alarm switch 2 contacts	J	BW9K2SHA	BW9K2SHA	BW9K2SHA	BW9K2SHA	
	Alarm low current	8	BW9K1DHA	BW9K1DHA	BW9K1DHA	BW9K1DHA	
	Alarm low current 2 contacts	9	BW9K2DHA	BW9K2DHA	BW9K2DHA	BW9K2DHA	
	Shunt trip	F	BW9FHA-*	BW9FHA-*	BW9FHA-*	BW9FHA-*	
	Under voltage trip	R	BW9RHA-*	BW9RHA-*	BW9RHA-*	BW9RHA-*	
Accessories with terminal block	A	See page 22	See page 22	See page 22	See page 22		
External accessories	Padlocking device *4	QN	BW9QNHA	BW9QNHA	BW9QNHA	BW9QNHA	
		Q2	BW9Q2JA	BW9Q2JA	BW9Q2JA	BW9Q2JA	
	External operating handle	V	BW9V0JA	BW9V0JA	BW9V0JA	BW9V0JA	
		N	BW9N0JA	BW9N0JA	BW9N0JA	BW9N0JA	
		Field Installable terminal	–	–	–	–	
	Terminal covers *3	Short type, gray-white	–	–	–	–	
			–	–	–	–	
BW9BTJA-L3W			BW9BTJA-L3W	BW9BTJA-L3W	BW9BTJA-L3W		
BW9BTJA-L3			BW9BTJA-L3	BW9BTJA-L3	BW9BTJA-L3		
Insulation barrier	B-43A	B-43A	B-43A	B-43A			
	B-43A	B-43A	B-43A	B-43A			
Mass: lb. (kg) (screw terminals)		19.62(8.9)	19.62(8.9)	20.72(9.4)	20.72(9.4)		

*1 Lug terminal is NOT available for 630 ampere.

*2 Flat terminal is NOT available for 800 ampere.

*3 Terminal covers are NOT supplied as standard.

*4 Non-UL item

●: Available, –: Not available

Earth Leakage Circuit Breakers - New G-Twin, UL489 Listed EW Series

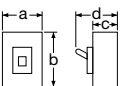
Frame size (A)		50	100				
Type		EW50RAGU-3P	EW100EAGU-2P EW100EAGU-3P				
Appearance (with Screw Terminals, 3 poles)							
SCCR=UL489 interrupting capacity							
Rated voltage AC (V)		UL 240 IEC 100-230-440	240 100-230 100-230-440				
Rated current (A)		3, 5, 10, 15, 20, 30, 32, 40, 50	60, 63, 70, 75, 80, 90, 100				
Rated Sensitive Current (mA)		30, 50, 100/200/500	30, 100/200 30, 50, 100/200/500				
Poles		3	2 3				
Rated frequency (Hz)		50/60	50/60 50/60				
Rated interrupting capacity sym (kA)	UL489 CAN/CSA C22.2 No.5	AC	480V/Δ	–	–		
			480V/Y	–	–		
			240V	14	14		
	IEC60947-2 JIS C 8201-2-2 Icu/Ics	AC	440V	10/5	–	10/5	
			415V	10/5	–	10/5	
			380V	10/5	–	10/5	
			230V	25/13	10/5	25/13	
			100V	25/13	10/5	25/13	
	GB14048.2 Icu/Ics	AC	400V	10/5	7.5/4	10/5	
			230V	25/13	10/5	25/13	
	Dimension inch (mm)			a	2.953(75)	2.953(75)	2.953(75)
				b	4.724(120)	4.724(120)	4.724(120)
c				2.362(60)	2.362(60)	2.362(60)	
d				3.307(84)	3.307(84)	3.307(84)	
Terminal construction	Screw terminals		None	●	●	●	
	Flat terminals		SF	●	●	●	
	Lug terminals		SB	–	–	–	
Internal accessories *4	Auxiliary switch		W	BZ6W*10CU	BZ6W*10CU	BZ6W*10CU	
	Alarm switch		K	BZ6K*10CU	BZ6K*10CU	BZ6K*10CU	
	Shunt trip		F	BZ6F*10CAU	BZ6F*10CAU	BZ6F*10CAU	
	Under voltage trip		R	BZ6R*10CAU	BZ6R*10CAU	BZ6R*10CAU	
	Accessories with terminal block		A	*1	*1	*1	
External accessories	Padlocking device (Cap type) *5		Q1	BZ6L10CA	BZ6L10CA	BZ6L10CA	
	Handle locking cover *5			BZ6L10C	BZ6L10C	BZ6L10C	
	External operating handle		V	BZ6V10D	BZ6V10D	BZ6V10D	
			N	BZ6N10D	BZ6N10D	BZ6N10D	
	Field Installable terminal kit	Flat terminal kit			BZ-SU20B	BZ-SU25B	BZ-SU25B
		Lug terminal kit			–	–	–
	Terminal covers *3	for screw, short type			Provided	Provided	Provided
		for screw, long type			BW9BTAA-L3W	BW9BTAA-L3W	BW9BTAA-L3W
		for flat terminal			–	–	–
		for Lug terminal			–	–	–
Insulation barrier *2			BZ6B10C	BZ6B10C	BZ6B10C		
Mass: lb. (kg) (screw terminals)			1.32(0.6)	1.32(0.6)	1.32(0.6)		

*1 For Internal accessories with terminal block, specify "A" in the accessory P/N. When 50A Frame & 100A Frame are ordered w/UVT, the UVT is supplied with terminal block as standard.

*2 Insulation barriers are only required with flat terminal.



*3 Short terminal covers are supplied as standard. If long terminal covers are required, please order BZ6TB10C2U or BZ6TB10C3U.

*4 These internal accessories can be installed in the field. (see page 20 for part number)

*5 Non-UL item

●: Available, –: Not available

Earth Leakage Circuit Breakers - New G-Twin, UL489 Listed EW Series

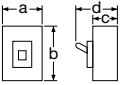
Frame size (A)		125		250			
Type		EW125JAGU	EW125RAGU	EW250JAGU	EW250RAGU		
Appearance (with Screw Terminals, 3 poles)							
SCCR=UL489 interrupting capacity							
Rated voltage AC (V)		UL 240-480 IEC 100-230-440	240-480 100-230-440	240-480 100-230-440	240-480 100-230-440		
Rated current (A)		15,20,30,40,50,60,75,100,125		125,150,160,175,200,225,250			
Instantaneous trip type	Rated Sensitive Current (mA)	B	30	30	30	30	
	Tripping time (s)		0.1 or less	0.1 or less	0.1 or less	0.1 or less	
Instantaneous /time-delay trip type	Rated Sensitive Current (mA)	K	100/200/500/1000	100/200/500/1000	100/200/500/1000	100/200/500/1000	
	Tripping time (s)		0.1/0.4/1/2	0.1/0.4/1/2	0.1/0.4/1/2	0.1/0.4/1/2	
	Inertia non-tripping time (s)		0/0.2/0.5/1	0/0.2/0.5/1	0/0.2/0.5/1	0/0.2/0.5/1	
Poles			3	3	3	3	
Rated frequency (Hz)			50/60	50/60	50/60	50/60	
Rated interrupting capacity sym (kA)	UL489 CAN/CSA C22.2 No.5	AC	480V/Δ	30	50	30	50
			480V/Y	30	50	30	50
			240V	50	100	50	100
	IEC60947-2 JIS C 8201-2-2 lcu/lcs	AC	440V	30/15	50/25	30/15	50/25
			415V	30/15	50/25	30/15	50/25
			380V	30/15	50/25	30/15	50/25
			240V	50/25	100/50	50/25	100/50
	GB14048.2 lcu/lcs	AC	400V	30/15	50/25	30/15	50/25
			230V	50/25	100/50	50/25	100/50
Dimension inch (mm)			a	3.543(90)	3.543(90)	4.134(105)	4.134(105)
			b	6.372(171)	6.372(171)	7.126(181)	7.126(181)
			c	2.677(68)	2.677(68)	2.677(68)	2.677(68)
			d	3.740(95)	3.740(95)	3.740(95)	3.740(95)
Terminal construction	Screw terminals	None	●	●	●	●	
	Flat terminals	SF	●	●	●	●	
	Lug terminals	SB	●	●	●	●	
Internal accessories	Auxiliary switch	W	BW9W1SG0(-R)	BW9W1SG0(-R)	BW9W1SG0(-R)	BW9W1SG0(-R)	
	Auxiliary switch for low current	1	BW9W1DG0(-R)	BW9W1DG0(-R)	BW9W1DG0(-R)	BW9W1DG0(-R)	
	Alarm switch	K	BW9K1SG0(-R)	BW9K1SG0(-R)	BW9K1SG0(-R)	BW9K1SG0(-R)	
	Alarm switch for low current	8	BW9K1DG0(-R)	BW9K1DG0(-R)	BW9K1DG0(-R)	BW9K1DG0(-R)	
	Auxiliary & Alarm switch	WK	BW9WKS0(-R)	BW9WKS0(-R)	BW9WKS0(-R)	BW9WKS0(-R)	
	Aux. & Alarm for low current	18	BW9WKDG0(-R)	BW9WKDG0(-R)	BW9WKDG0(-R)	BW9WKDG0(-R)	
	Shunt trip	F	BW9F*G0	BW9F*G0	BW9F*G0	BW9F*G0	
	Under voltage trip	R	BW9RGA*	BW9RGA*	BW9RGA*	BW9RGA*	
	Earth alarm switch *2	L	▲	▲	▲	▲	
Accessories with terminal block	A	See page 22	See page 22	See page 22	See page 22		
External accessories	Padlocking device *3	Q1	BW9Q1CA	BW9Q1CA	BW9Q1CA	BW9Q1CA	
		Q2	BW9Q2CA	BW9Q2CA	BW9Q2GA	BW9Q2GA	
	External operating handle	V	BW9V0CA	BW9V0CA	BW9V0GA	BW9V0GA	
		N	BW9N0CA	BW9N0CA	BW9N0GA	BW9N0GA	
		F	BW9F0CA	BW9F0CA	BW9F0GA	BW9F0GA	
	Field Installable terminal kit	Flat terminal kit	BW9SS0CA-3 GLOBAL		BZ-S50B-2253 GLOBAL		
		Lug terminal kit	BW9SL0CA-3 GLOBAL		Please see page 28.		
	Terminal covers *1	Short type, gray-white	Provided		Provided		
		Short type, transparent	BW9BTCA-S3	BW9BTCA-S3	BW9BTGA-S3	BW9BTGA-S3	
Long type, gray-white		BW9BTCA-L3W	BW9BTCA-L3W	BW9BTGA-L3W	BW9BTGA-L3W		
Long type, transparent		BW9BTCA-L3	BW9BTCA-L3	BW9BTGA-L3	BW9BTGA-L3		
Insulation barrier		BW9BPCA	BW9BPCA	BW9BPGA	BW9BPGA		
Mass: lb. (kg) (screw terminals)		2.65(1.2)	2.65(1.2)	3.53(1.6)	3.53(1.6)		



*1 Short type terminal covers (gray-white) are supplied as standard.

*2 Right-side mount only.

*3 Non-UL item

●: Available, -: Not available, ▲: Factory-install Order P/N Ex: EW125JAGU-3P015SBL

Earth Leakage Circuit Breakers - New G-Twin, UL489 Listed EW Series

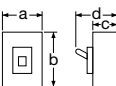
Frame size (A)		400			630		
Type		EW400SAGU	EW400RAGU	EW400HAGU	EW630RAGU		
Appearance (with Flat Terminals, 3 poles)							
SCCR=UL489 interrupting capacity							
Rated voltage AC (V)		UL 240-480 IEC 100-230-440	240-480 100-230-440	240-480 100-230-440	240-480 100-230-440		
Rated current (A)		250, 300, 350, 400			500, 600, 630		
Instantaneous trip type	Rated Sensitive Current (mA)	B	30	30	30	-	
	Tripping time (s)		0.1 or less	0.1 or less	0.1 or less	-	
Instantaneous /time-delay trip type	Rated Sensitive Current (mA)	K	100/200/500/1000	100/200/500/1000	100/200/500/1000	100/200/500/1000	
	Tripping time (s)		0.1/0.4/1/2	0.1/0.4/1/2	0.1/0.4/1/2	0.1/0.4/1/2	
	Inertia non-tripping time (s)		0/0.2/0.5/1	0/0.2/0.5/1	0/0.2/0.5/1	0/0.2/0.5/1	
Poles		3		3	3	3	
Rated frequency (Hz)		50/60		50/60	50/60	50/60	
Rated interrupting capacity sym (kA)	UL489 CAN/CSA C22.2 No.5	AC	480V/Δ	35	50	65 (50: with lug terminals)	50
			480V/Y	35	50	65 (50: with lug terminals)	50
			240V	50	100	125	100
	IEC60947-2 JIS C 8201-2-2 lcu/lcs	AC	440V	36/18	50/25	70/35	50/25
			415V	36/18	50/25	70/35	50/25
			380V	36/18	50/25	70/35	50/25
			240V	85/43	100/50	125/63	100/50
	GB14048.2 lcu/lcs	AC	100V	85/43	100/50	125/63	100/50
			400V	36/18	50/25	70/35	50/25
			230V	85/43	100/50	125/63	100/50
Dimension inch (mm)		a	5.512(140)	5.512(140)	5.512(140)	8.268(210)	
		b	10.12(257)	10.12(257)	10.12(257)	10.83(275)	
		c	4.055(103)	4.055(103)	4.055(103)	4.055(103)	
		d	5.748(146)	5.748(146)	5.748(146)	5.748(146)	
		d-c	-	-	-	-	
Terminal construction	Screw terminals	-	-	-	-	-	
	Flat terminals	None	●	●	●	●	
	Lug terminals	SB	●	●	●	●*1	
Internal accessories	Auxiliary switch	W	BW9W1SHA	BW9W1SHA	BW9W1SHA	BW9W1SHA	
	Auxiliary switch, 2 contacts	V	BW9W2SHA	BW9W2SHA	BW9W2SHA	BW9W2SHA	
	Aux. low current	1	BW9W1DHA	BW9W1DHA	BW9W1DHA	BW9W1DHA	
	Aux. low current, 2 contacts	2	BW9W2DHA	BW9W2DHA	BW9W2DHA	BW9W2DHA	
	Alarm switch	K	BW9K1SHA	BW9K1SHA	BW9K1SHA	BW9K1SHA	
	Alarm switch, 2 contacts	J	BW9K2SHA	BW9K2SHA	BW9K2SHA	BW9K2SHA	
	Alarm low current	8	BW9K1DHA	BW9K1DHA	BW9K1DHA	BW9K1DHA	
	Alarm low current, 2 contacts	9	BW9K2DHA	BW9K2DHA	BW9K2DHA	BW9K2DHA	
	Shunt trip	F	BW9FHA-*	BW9FHA-*	BW9FHA-*	BW9FHA-*	
	Under voltage trip	R	BW9RHA-*	BW9RHA-*	BW9RHA-*	BW9RHA-*	
	Earth alarm switch *2	L	▲	▲	▲	▲	
	Accessories with terminal block	A	See page 22	See page 22	See page 22	See page 22	
External accessories	Padlocking device *3	QN	BW9QNHA	BW9QNHA	BW9QNHA	BW9QNHA	
		Q2	BW9Q2HA	BW9Q2HA	BW9Q2HA	BW9Q2HA	
	External operating handle	V	BW9V0HA	BW9V0HA	BW9V0HA	BW9V2JA	
		N	BW9N0HA	BW9N0HA	BW9N0HA	BW9N0JA	
		F	BW9F0HA	BW9F0HA	BW9F0HA	-	
	Field Installable terminal	-	-	-	-		
	Terminal covers *4	Short type, gray-white	BW9BTHA-S3W	BW9BTHA-S3W	BW9BTHA-S3W	-	
			BW9BTHA-S3	BW9BTHA-S3	BW9BTHA-S3	-	
			BW9BTHA-L3W	BW9BTHA-L3W	BW9BTHA-L3W	BW9BTHA-L3W	
			BW9BTHA-L3	BW9BTHA-L3	BW9BTHA-L3	BW9BTHA-L3	
Insulation barrier		B43-A	B43-A	B43-A	B43-A		
Mass: lb. (kg) (screw terminals)		12.35(5.6)		12.35(5.6)	12.35(5.6)	-	

*1 Lug Terminal is NOT available for 630 ampere.

*2 Right-side mount only

*3 Non-UL item

*4 Terminal covers are NOT supplied as standard.

●: Available, -: Not available, ▲: Factory-install Order P/N Ex: EW400SAGU-3P250SBL

Part Number Structure

G-TWIN; MCCB (50 - 800AF)

BW250EAGU - 3P 100 SF

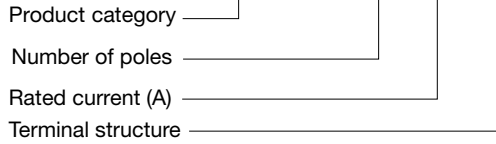

Code	Line side	Load side	BW50RAGU	BW100EAGU, BW125RAGU, BW125RAGU BW250EAGU, BW125JAGU, BW250RAGU	BW400EAGU, BW400SAGU, BW400RAGU, BW400HAGU BW630RAGU, BW630HAGU, BW800RAGU, BW800HAGU
None	Screw	Screw	●	●	-
None	Flat	Flat	-	-	●
SB	Lug	Lug	-	●	●*1
SF	Flat	Flat	●	●	-

*1 Lug terminal is Not available for BW630□AGU-3P630 (Rated current 630 ampere in BW630).

G-TWIN; ELCB (50 - 630AF)

EW50RAGU - 3P 050 K SF L

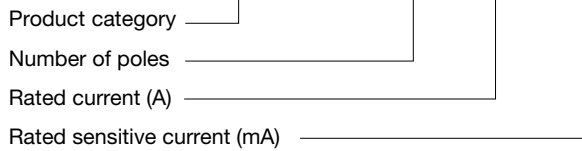

Code	Line side	2 poles	3 poles
B	30mA	●	●
D	50mA*	-	●
K	100/200mA** changeable	●	-
K	100/200/500* or 100/200/500/1000mA changeable	-	●

*Only for EW50RAGU-3P, EW100EAGU-3P

**Only for EW100EAGU-2P

Earth Alarm Switch
(Factory install optional accessory)
Only for EW125,EW250,EW400,EW630

Terminal structure

Code	Line side	Load side	EW50RAGU EW100EAGU	EW125JAGU, EW125RAGU EW125JAGU, EW250RAGU	EW400SAGU, EW400RAGU, EW400HAGU EW630RAGU
None	Screw	Screw	●	●	-
None	Flat	Flat	-	-	●
SB	Lug	Lug	-	●	●*1
SF	Flat	Flat	●	●	-

*1 Lug terminal is Not available for EW630RAGU-3P630 (Rated current 630 ampere in EW630).

G-TWIN; MCCB/ELCB Internal & External Accessories

BZ6 *

Follow page 3, 7
(50 - 100AF)

BW9 *

Follow page 4, 5, 6, 8, 9
(125 - 800AF)

Characteristic Curves

● BW50RAGU, EW50RAGU (Rated current: 5A, 10A, 32A, 40A)

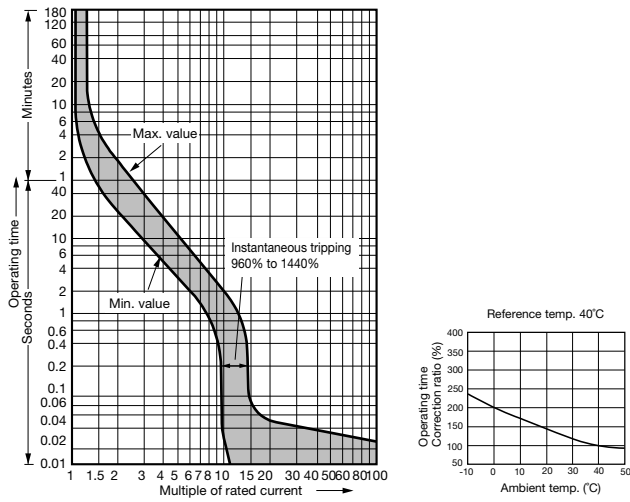

● BW50RAGU, EW50RAGU (Rated current: 3A, 15A, 20A, 30A, 50A)

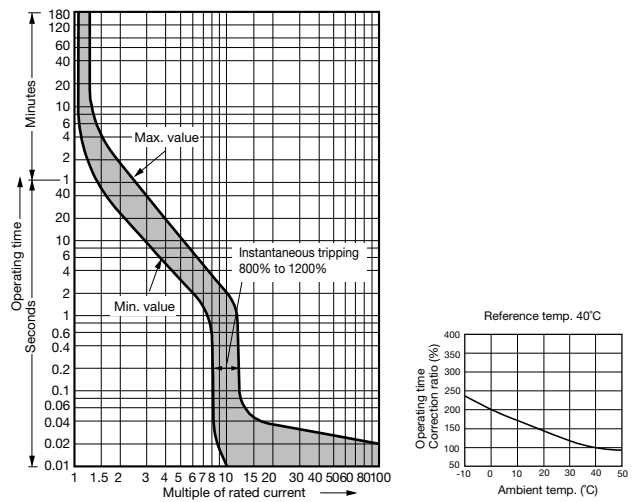

● BW100EAGU, EW100EAGU (Rated current: 60A, 63A, 75A, 80A, 90A)

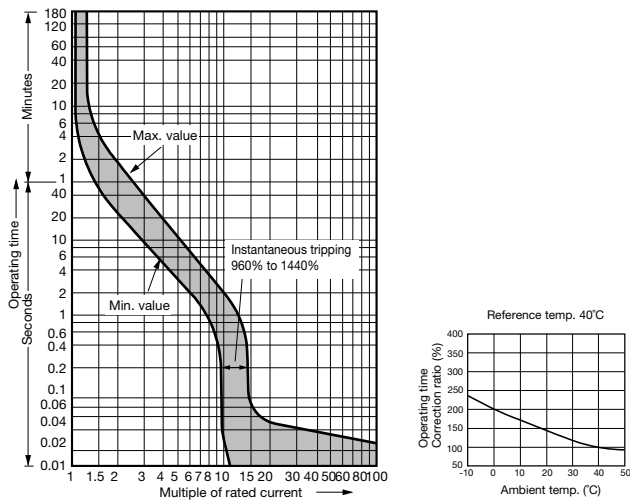

● BW100EAGU, EW100EAGU (Rated current: 100A)

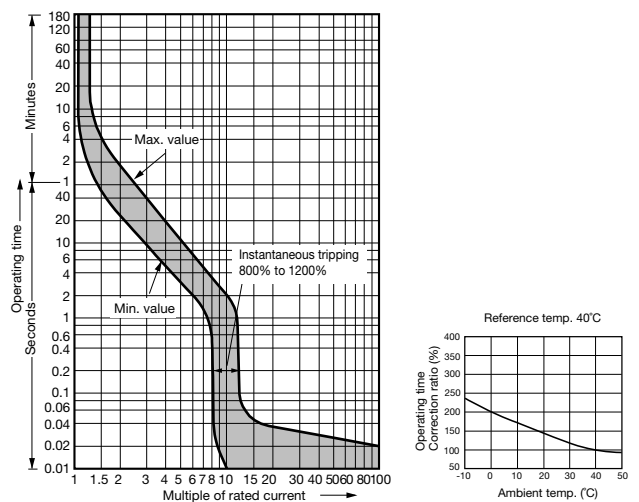

● BW125, EW125 (Rated current: 15A)

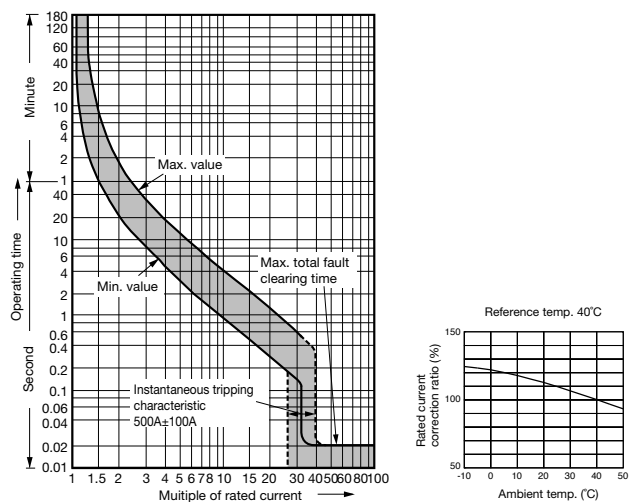

● BW125, EW125 (Rated current: 20A)

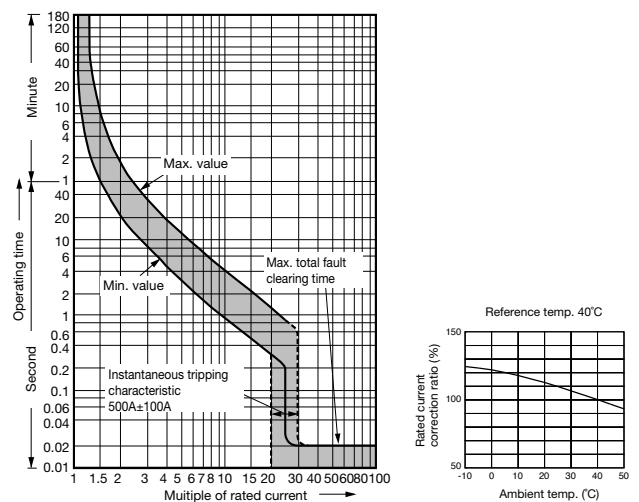

Characteristic Curves

● BW125, EW125 (Rated current: 30A)

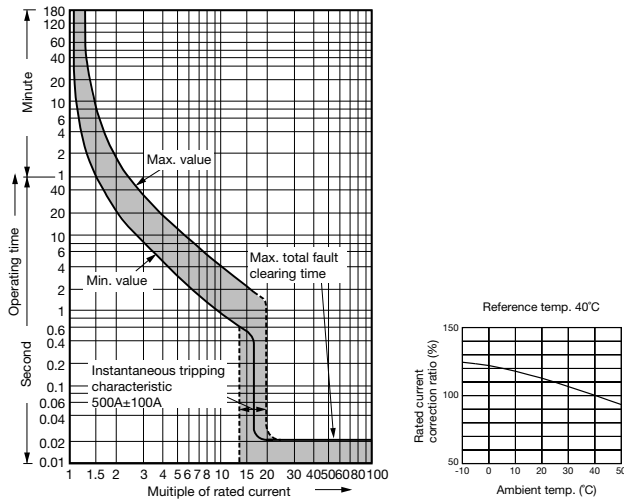

● BW125, EW125 (Rated current: 40A)

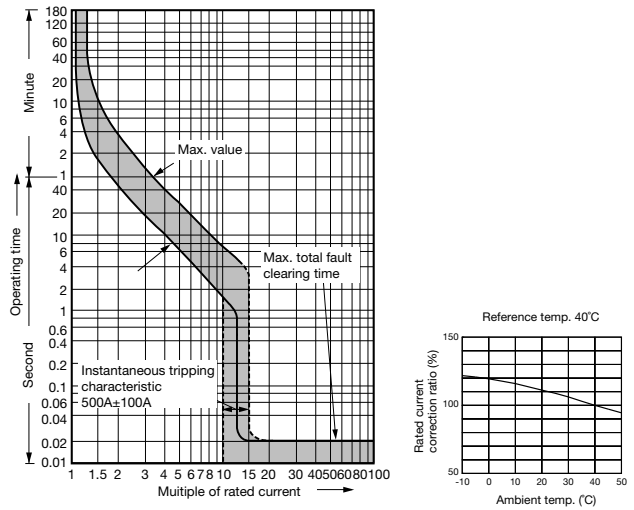

● BW125, EW125 (Rated current: 50 - 125A)

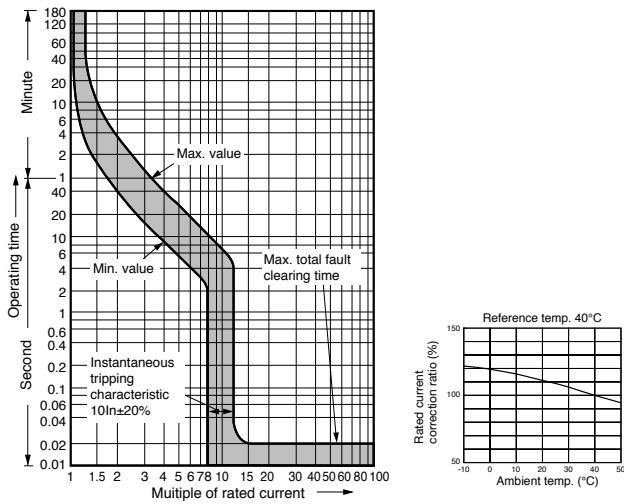

● BW250, EW250

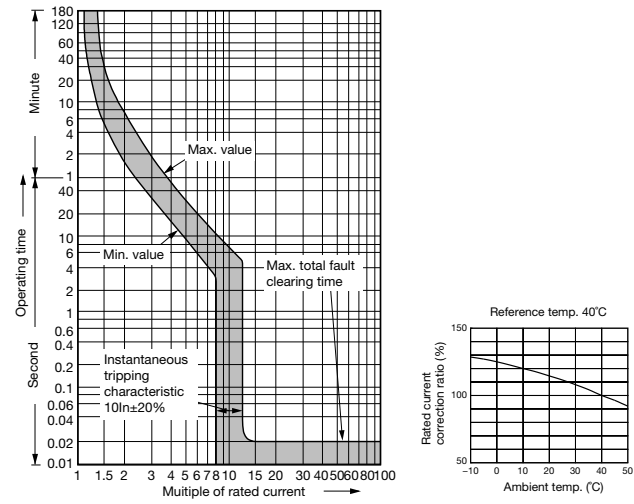

● BW400, EW400

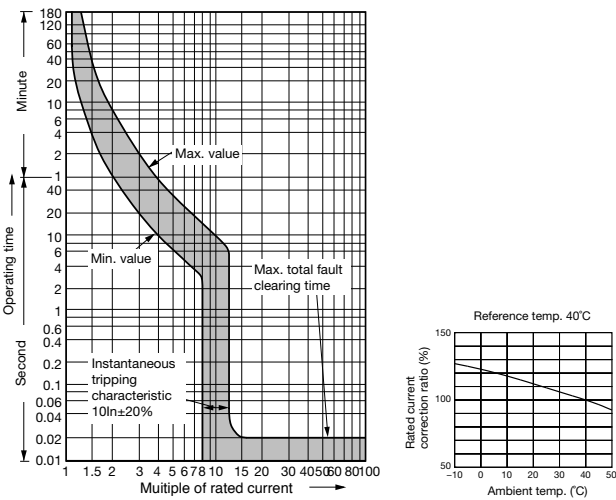

● BW630, EW630

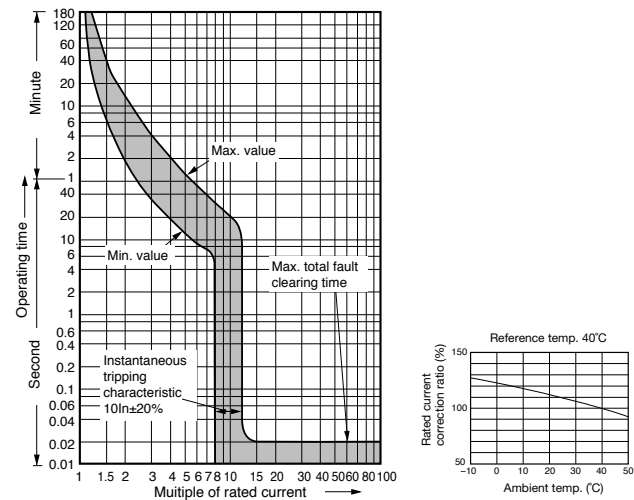

Characteristic Curves

● BW800

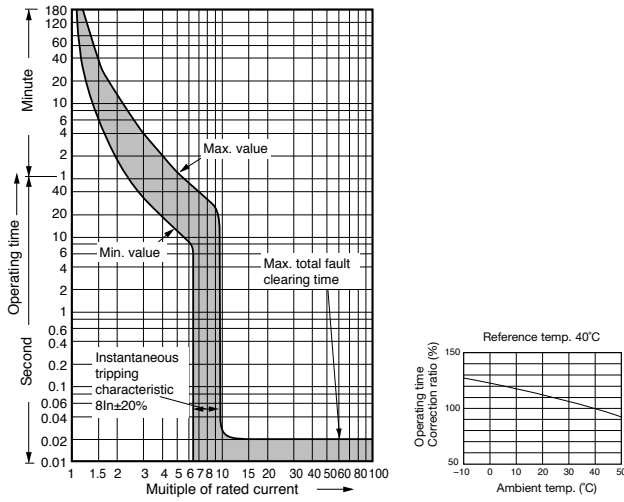

● Earth leakage tripping (EW50, EW100)

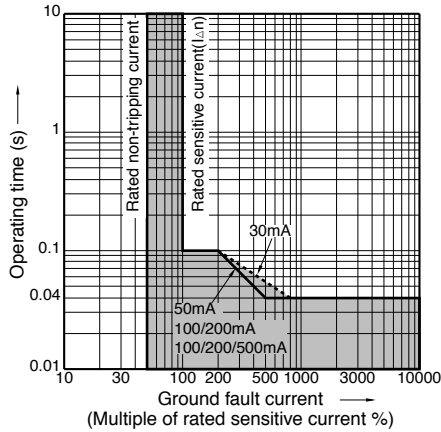

● Earth leakage tripping (EW125, EW250, EW400, EW630)

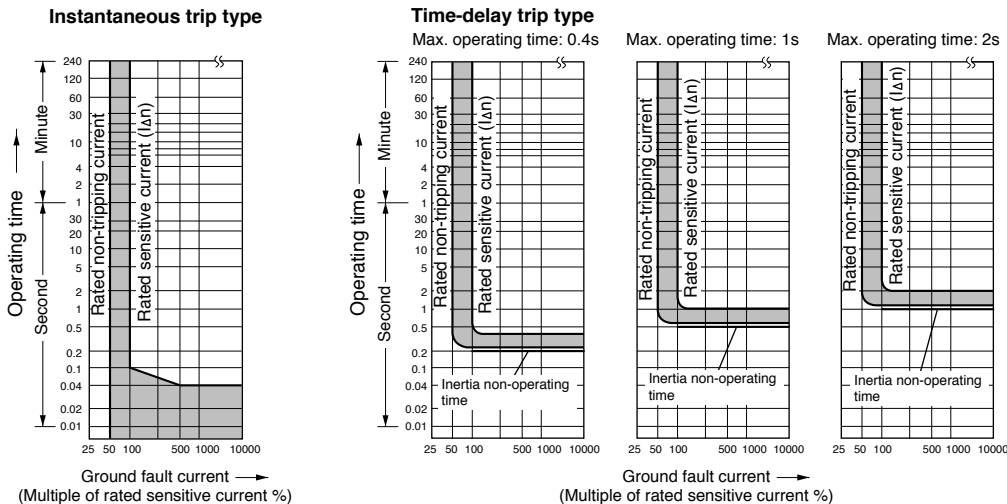

Dimensions: inch (mm)

BW50RAGU-2P, 3P, BW100EAGU-2P, 3P, EW50RAGU-3P, EW100EAGU-2P*, 3P

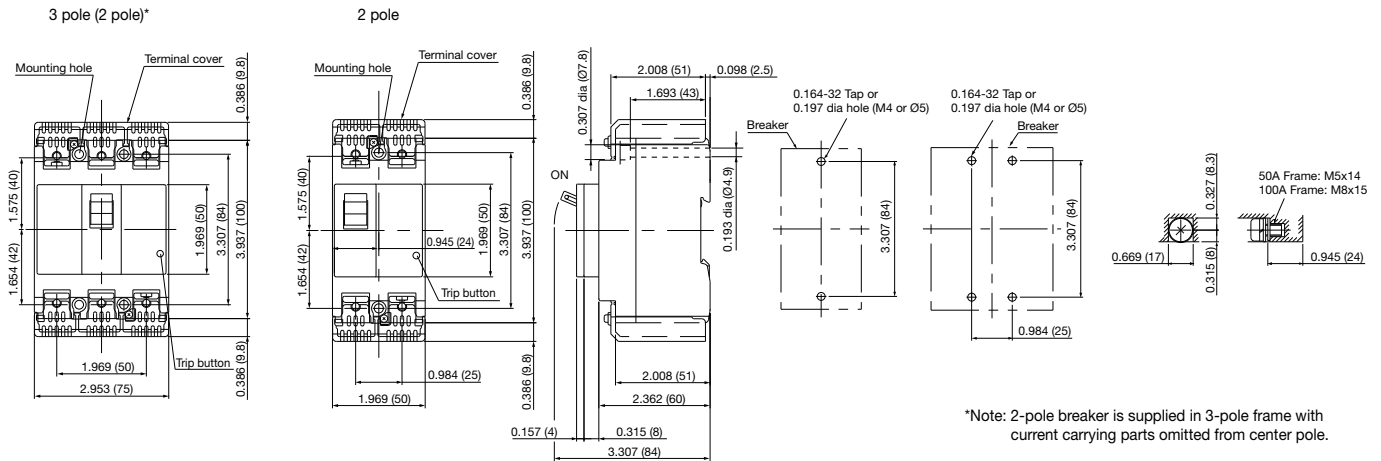

BW50RAGU-2P, 3P(SF), EW50RAGU-3P(SF)

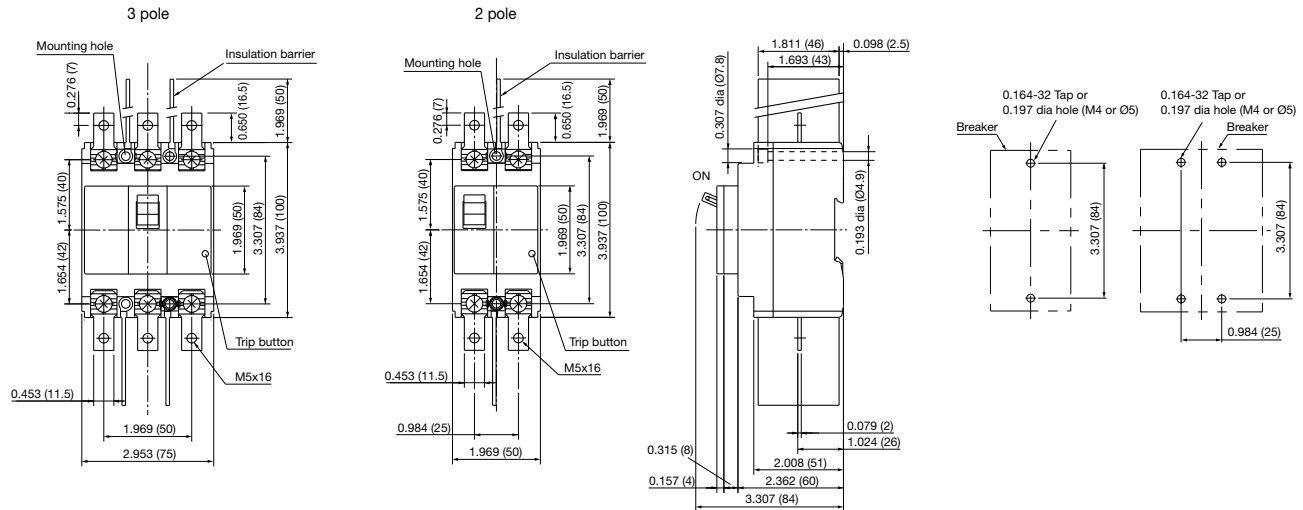

BW100EAGU-2P, 3P(SF), EW100EAGU-2P*, 3P(SF)

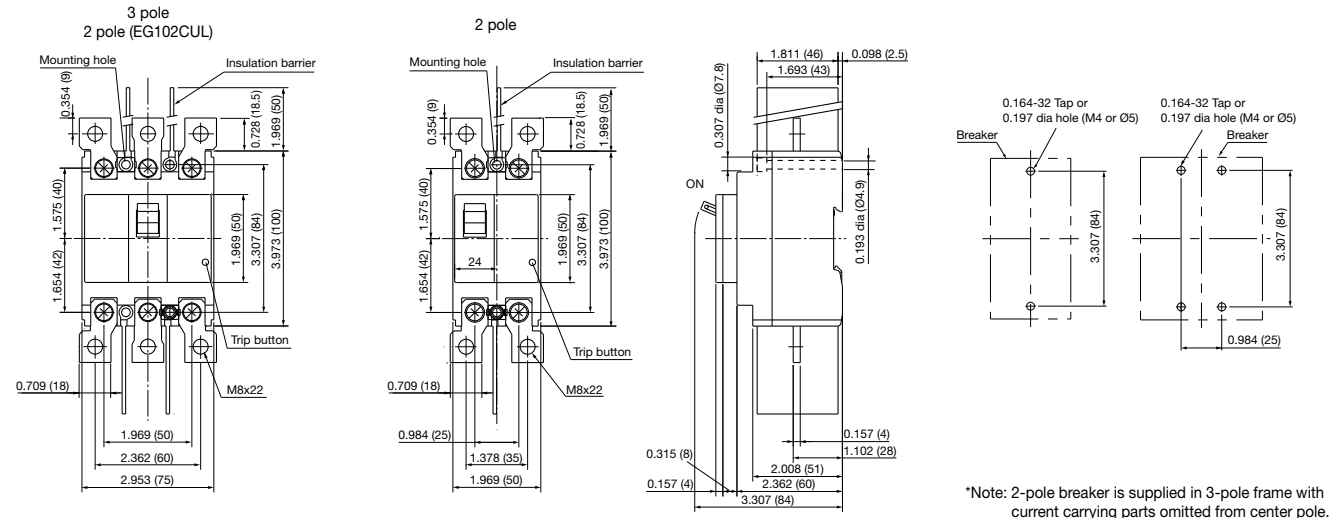

Dimensions: inch (mm)

BW125*U-2P, 3P

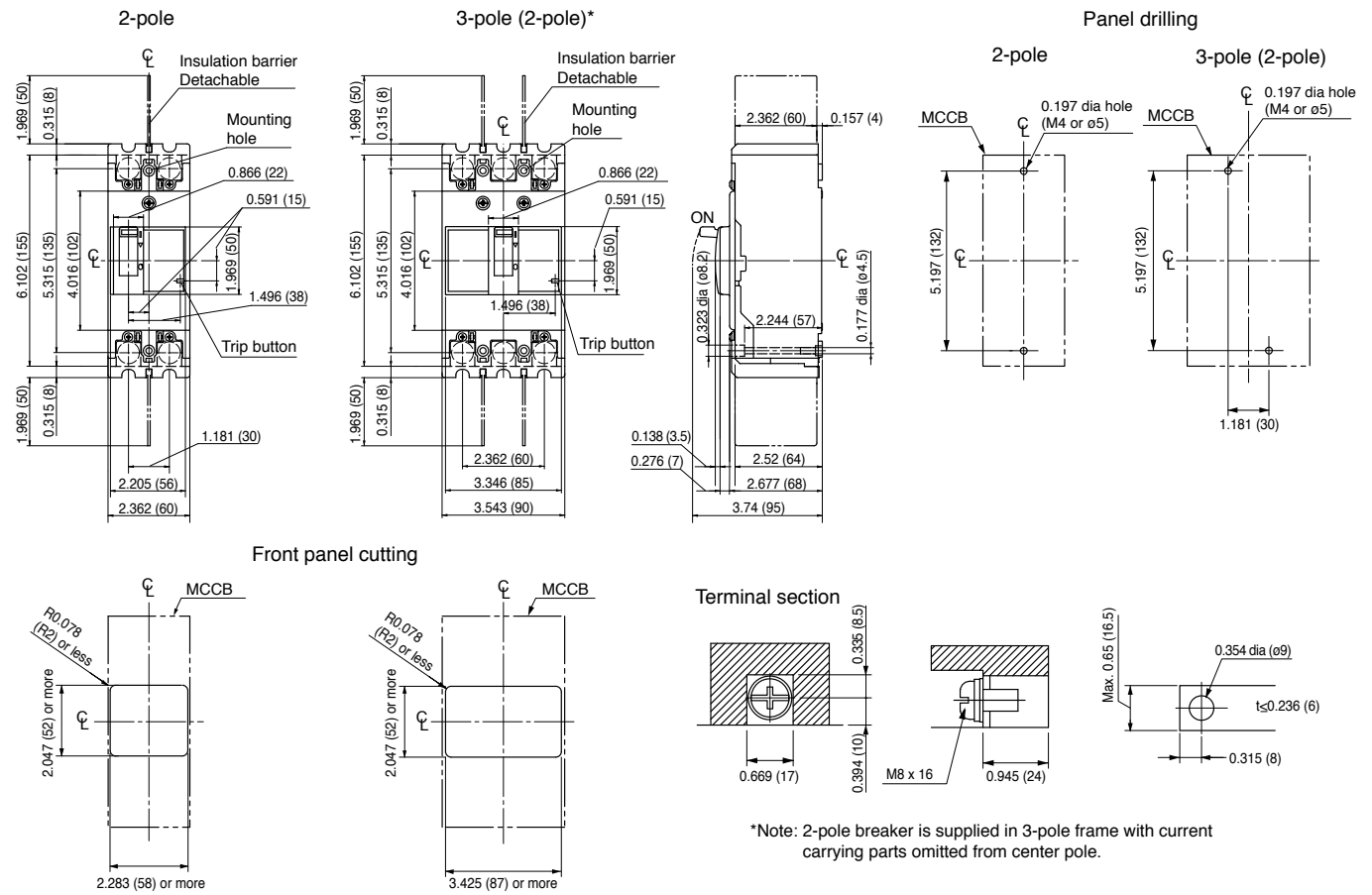

BW250*U-2P, 3P

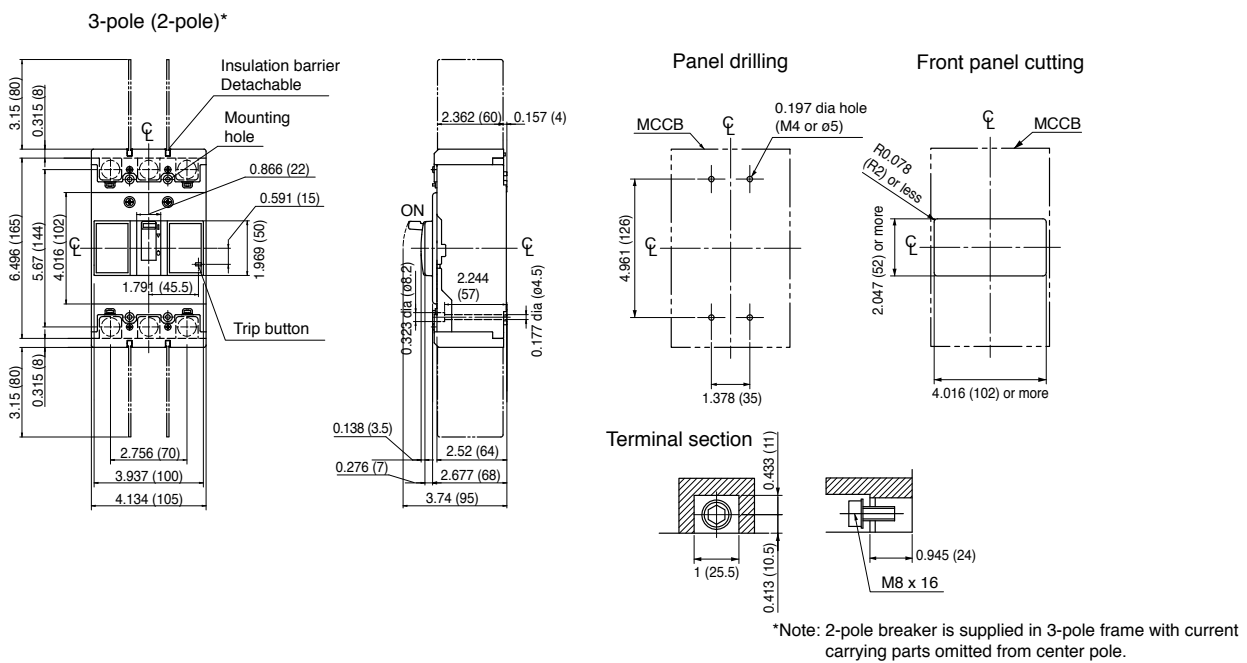

Dimensions: inch (mm)

BW400*U-2P, 3P

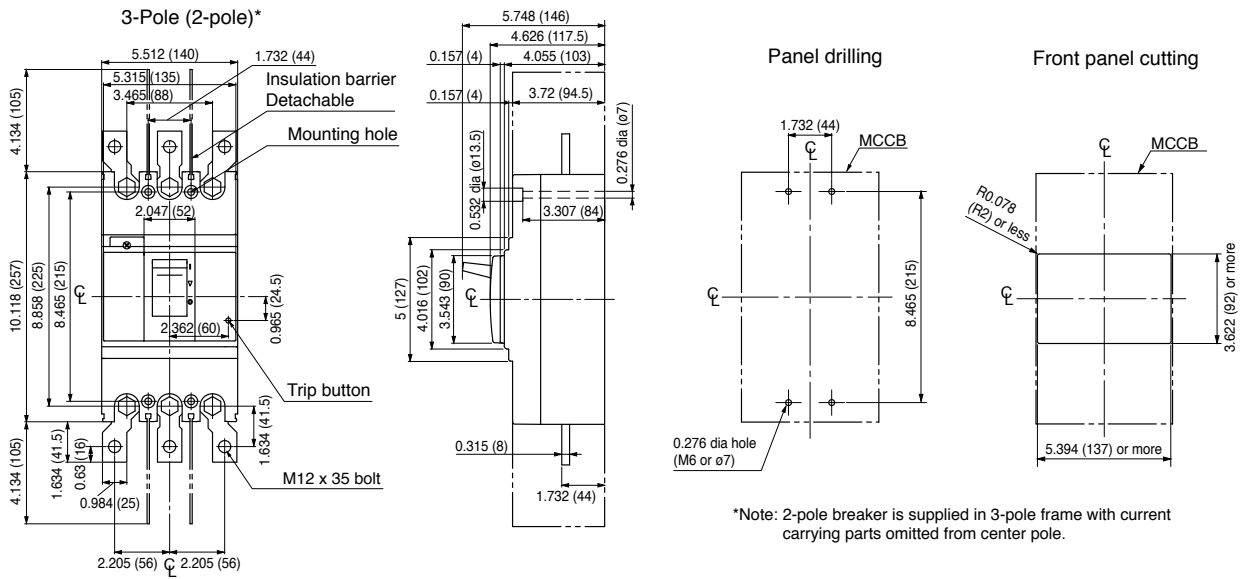

BW630*U-3P

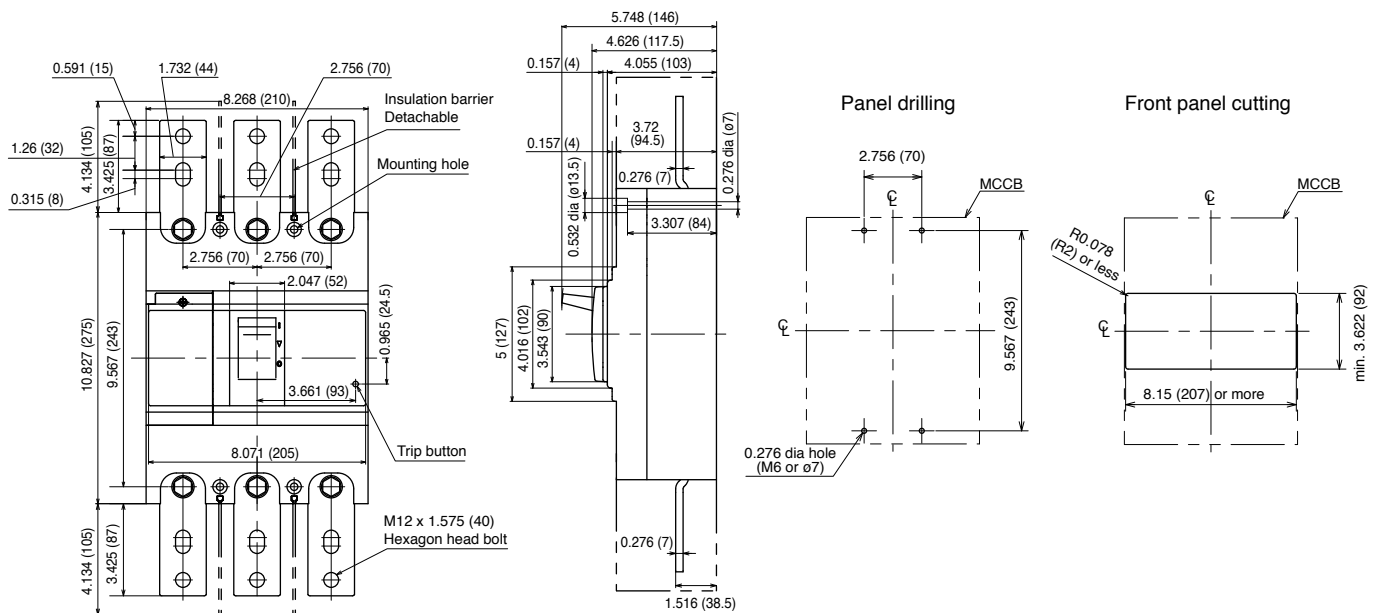

Dimensions: inch (mm)

BW800*U-3P

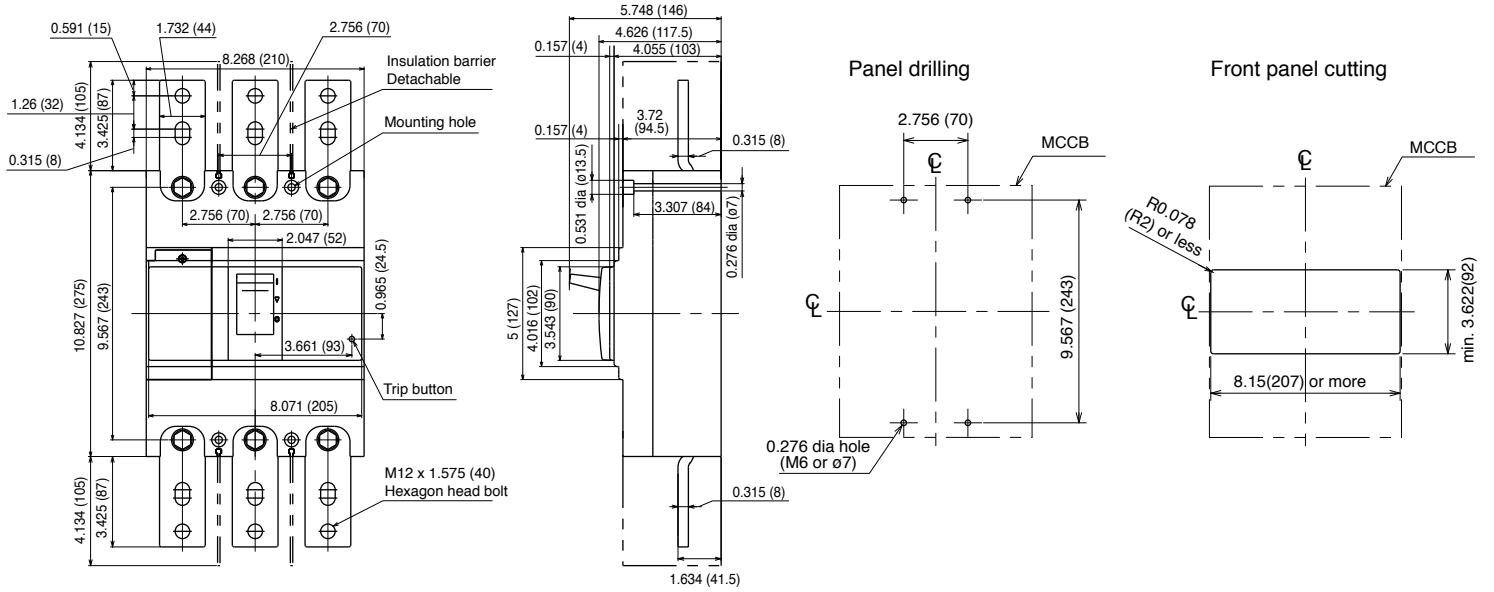

EW125*U-3P

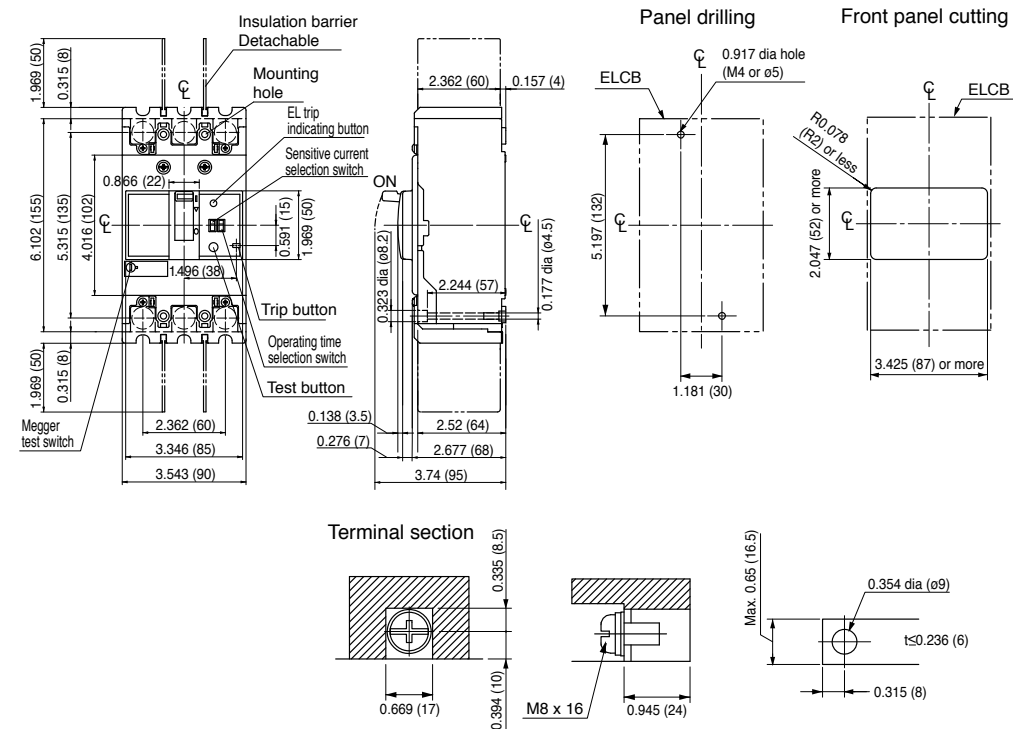

Dimensions: inch (mm)

EW250°U-3P

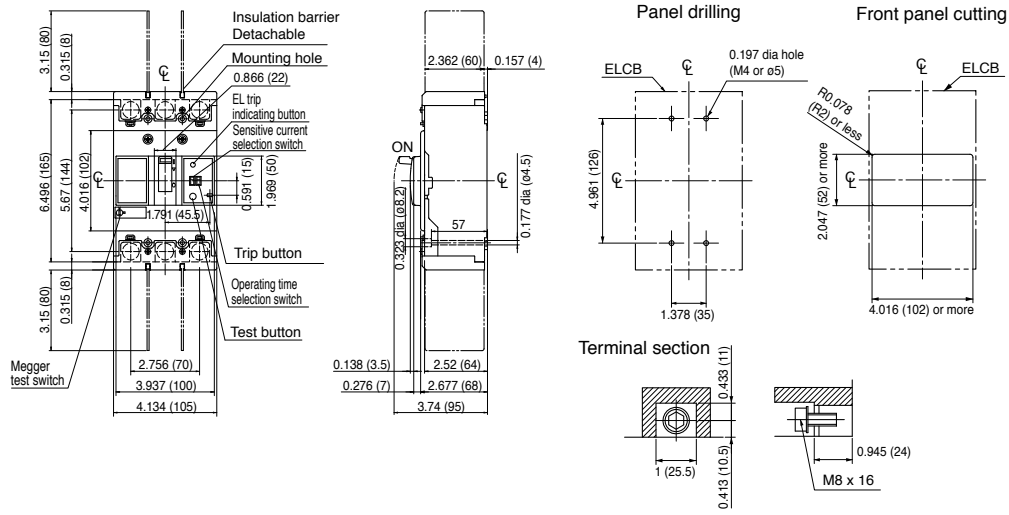

EW400°U-3P

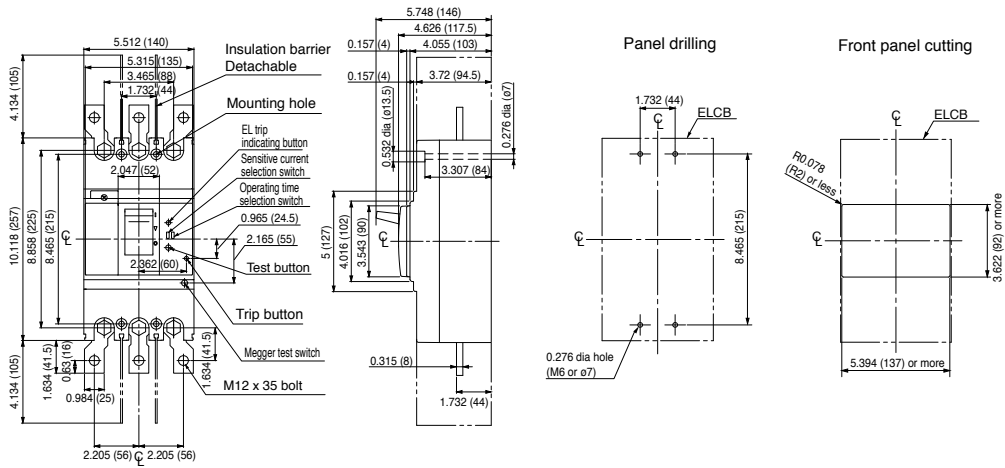

EW630RAGU-3P

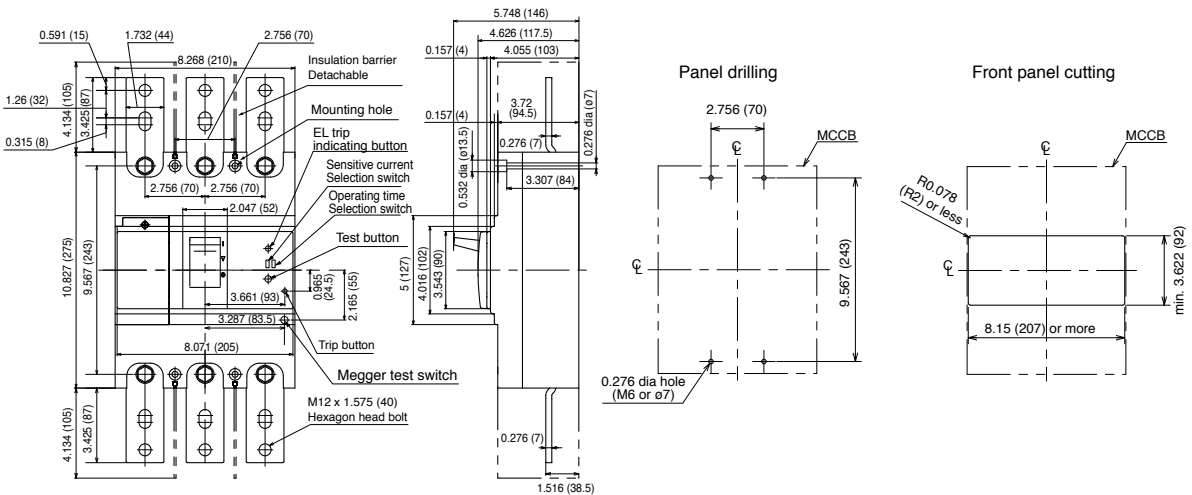

Dimensions of Terminal Blocks for Internal Accessories: inch (mm)

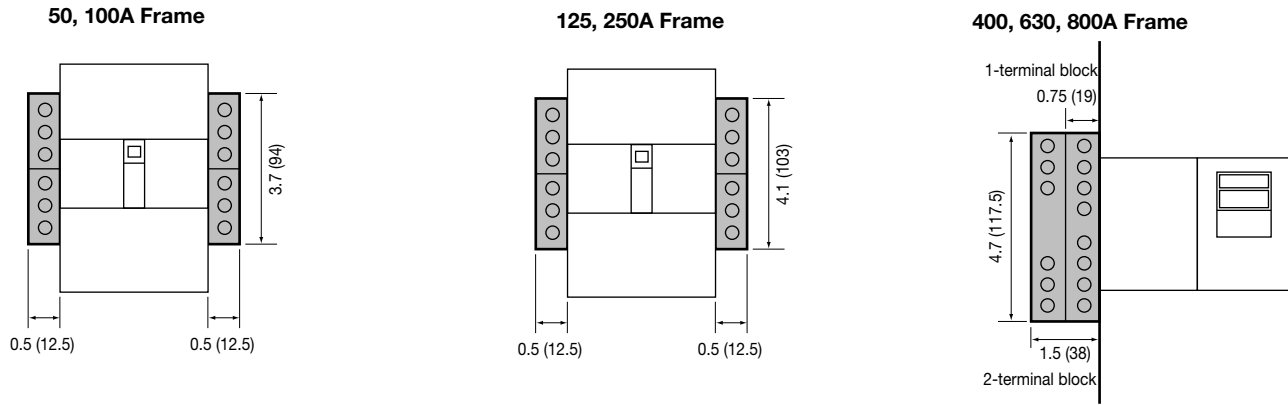

Dimensions of Undervoltage/Shunt trip device 50 and 100AF Only

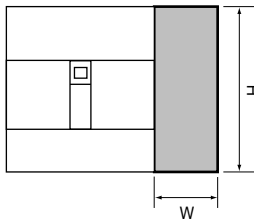

Breakers	W x H
BW50RAGU-2P, BW100EAGU-2P	1.0 (25) x 3.94 (100)
BW50RAGU-3P, BW100EAGU-3P EW50RAGU, EW100EAGU	1.0 (25) x 3.94 (100)

Dimensions of Terminal Covers: inch (mm)

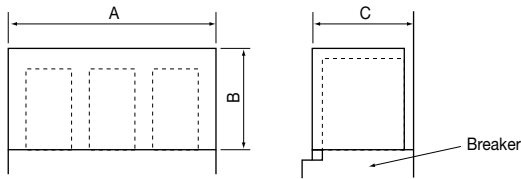

Type			Dimensions: Inch(mm)			Applicable Breakers
Black	Transparent	Gray-white	A	B	C	
-	BW9BTAA-S2 (Short)	BW9BTAA-S2W ** (Short)	1.969 (50)	0.386 (9.8)	2.106 (53.5)	BW50RAGU-2P, BW100EAGU-2P
-	BW9BTAA-L2 (Long)	BW9BTAA-L2W (Long)	1.969 (50)	1.575 (40)	2.106 (53.5)	
-	BW9BTAA-S3 (Short)	BW9BTAA-S3W** (Short)	2.953 (75)	0.386 (9.8)	2.106 (53.5)	BW50RAGU-3P, BW100EAGU-3P EW50RAGU-3P, EW100EAGU-2P
-	BW9BTAA-L3 (Long)	BW9BTAA-L3W (Long)	2.953 (75)	1.575 (40)	2.106 (53.5)	
-	BW9BTCA-S2 (Short)	BW9BTCA-S2W** (Short)	2.362 (60)	0.315 (8)	2.618 (66.5)	BW125*U-2P
-	BW9BTCA-L2 (Long)	BW9BTCA-L2W (Long)	2.362 (60)	1.575 (40)	2.618 (66.5)	
-	BW9BTCA-S3 (Short)	BW9BTCA-S3W** (Short)	3.543 (90)	0.315 (8)	2.618 (66.5)	BW125*U-3P EW125*U-3P
-	BW9BTCA-L3 (Long)	BW9BTCA-L3W (Long)	3.543 (90)	1.575 (40)	2.618 (66.5)	
-	BW9BTGA-S3 (Short)	BW9BTGA-S3W** (Short)	4.134 (105)	0.315 (8)	2.618 (66.5)	BW250*U-2P, BW250*U-3P EW250*U-3P
-	BW9BTGA-L3 (Long)	BW9BTGA-L3W (Long)	4.134 (105)	1.969 (50)	2.618 (66.5)	
-	BW9BTHA-S3 (Short)	BW9BTHA-S3W (Short)	5.512 (140)	2.559 (65)	3.858 (98)	BW400*U-2P, BW400*U-3P EW400*U-3P
-	BW9BTHA-L3 (Long)	BW9BTHA-L3W (Long)	6.772 (172)	4.331 (110)	3.858 (98)	
-	BW9BTJA-L3 (Long)	BW9BTJA-L3W (Long)	8.268 (210)	6.102 (155)	3.858 (98)	BW630*U-3P, BW800*U-3P EW630*U-3P

**A Gray-white terminal cover provided with BW50□U, BW100□U, BW125□U, BW250□U, EW100□U, EW125□U, EW250□U amp frame.

Internal Accessories for G-TWIN

50,100AF

Breaker type: BW50, BW100, EW50, EW100

Auxiliary switches and alarm switches

Lead wire type		BW50RAGU, EW50RAGU BW100EAGU, EW100EAGU	
		Left side	Right side
Aux	W	BZ6WL10CU*1	BZ6WR10CU
Aux low current	WD	BZ6WDL10CU*1	BZ6WDR10CU
Alarm	K	BZ6KL10CU*1	BZ6KR10CU
Alarm low current	KD	BZ6KDL10CU*1	BZ6KDR10CU
Aux & Alarm	WK	BZ6WKL10CU*1	BZ6WKR10CU
Aux & Alarm low current	WDKD	BZ6WDKDL10CU*1	BZ6WDKDR10CU

*1 for 3 pole type only

With terminal block type		BW50RAGU, EW50RAGU BW100EAGU, EW100EAGU	
		Left side	Right side
Aux	W	BZ6WL10CAU*1	BZ6WR10CAU
Aux low current	WD	BZ6WDL10CAU*1	BZ6WDR10CAU
Alarm	K	BZ6KL10CAU*1	BZ6KR10CAU
Alarm low current	KD	BZ6KDL10CAU*1	BZ6KDR10CAU
Aux & Alarm	WK	BZ6WKL10CAU*1	BZ6WKR10CAU
Aux & Alarm low current	WDKD	BZ6WDKDL10CAU*1	BZ6WDKDR10CAU

*1 for 3 pole type only

Rating

Standard; Aux, Alarm

Breaker type	BW50RAGU, EW50RAGU BW100EAGU, EW100EAGU	Minimum load
Operating voltage	Rated current (A)	5V DC 160mA 30V DC 30mA
120V AC	3.6	
240V AC	1.8	
125V DC	0.55	
250V DC	0.27	

For low current; Aux, Alarm

Breaker type	BW50RAGU, EW50RAGU BW100EAGU, EW100EAGU	Minimum load
Operating voltage	Rated current (A)	5V DC 1mA 30V DC 1mA
30V DC	0.1	

Operation

Type of switch	Condition of MCCB	
	ON	OFF
Auxiliary switch (W)		
Alarm switch (K)		

Shunt trip devices

Breaker type	Operating voltage	Code	Part number		Spec		
			Lead wire type	With terminal block type	Input (VA)	Internal circuit	Time rating (ms)
BW50RAGU BW100EAGU	24VAC, 24VDC	FR	BZ6FR10CU	BZ6FR10CAU	150	Continuous with burnout prevention circuit	7-13
	100-120VAC 100-110VDC	FA	BZ6FA10CU	BZ6FA10CAU	150		
	200-240VAC	FK	BZ6FK10CU	BZ6FK10CAU	150		
	380-450VAC	FP	BZ6FP10CU	BZ6FP10CAU	200		
EW50RAGU EW100EAGU	100VAC 50Hz 100-110VAC 60Hz	F2	-	BZ6F210CAU	16	Continuous	7-13
	200VAC 50Hz 200-220VAC 60Hz	F7	-	BZ6F710CAU	16		
	400VAC 50Hz	F8	-	BZ6F810CAU	22		
	400-440VAC 60Hz						

Undervoltage trip devices

Breaker type	Operating voltage	Code	Part number		Spec	
			Lead wire type	With terminal block type	Input	Operating voltage
BW50RAGU BW100EAGU	100VAC 50Hz 100-110VAC 60Hz	R2	-	BZ6R210CAU	2.8 VA	Tripping voltage: 70% to 35% of rated voltage
	200VAC 50Hz	RW	-	BZ6RW10CAU	3.4 VA	
EW50RAGU EW100EAGU	200-220VAC 60Hz					Closing voltage: 85% or more of rated voltage
	400VAC 50Hz 400-440VAC 60Hz	R9	-	BZ6R910CAU	4.4 VA	
	24VDC	RF	-	BZ6RF10CAU	40W	

Internal Accessory Combinations for G-TWIN

50,100AF

Breaker type: BW50, BW100, EW50, EW100

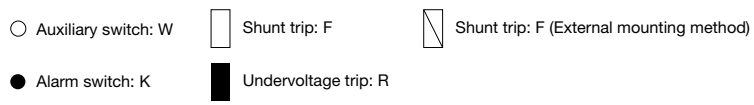
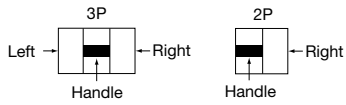

MCCB	BW50RAGU-2P BW100EAGU-2P	BW50RAGU-3P BW100EAGU-3P
Pole	2	3
Auxiliary switch SPDT W		
Alarm switch SPDT K		
Shunt trip F		
Undervoltage trip R		
W2	N/A	
W+K		
W2+K	N/A	
K2	N/A	
W+K2	N/A	
W2+K2	N/A	
W+F	N/A	
W2+F	N/A	N/A
W+R		
W2+R	N/A	
K+F	N/A	
K+R		
W+K+F	N/A	
W+K+R		
K2+F	N/A	N/A
K2+R	N/A	
W2+K+F	N/A	N/A
W2+K+R	N/A	
W+K2+F	N/A	N/A
W+K2+R	N/A	
W2+K2+F	N/A	N/A
W2+K2+R	N/A	

ELCB	EW50RAGU-3P EW100EAGU-2P EW100EAGU-3P
Pole	2, 3
Auxiliary switch SPDT W	
Alarm switch SPDT K	
Shunt trip F	
Undervoltage trip R	
W2	
W+K	
W2+K	
K2	
W+K2	
W2+K2	
W+F	
W+R	
W2+R	
K+F	
K+R	
K2+R	
W+K+F	
W+K+R	
W2+K+R	
W+K2+R	
W2+K2+R	

Internal Accessories for G-TWIN

125, 250AF

Breaker type: BW125, EW125, BW250, EW250

Accessory	Code	Part number				Operating voltage
		Lead wire type		With terminal block type		
		Left side	Right side	Left side	Right side	
Auxiliary switch	W	BW9W1SG0	BW9W1SG0-R	BW9W1SG0-A	BW9W1SG0-RA	–
Auxiliary switch (low current)	1	BW9W1DG0	BW9W1DG0-R	–	–	
Alarm switch	K	BW9K1SG0	BW9K1SG0-R	BW9K1SG0-A	BW9K1SG0-RA	
Alarm switch (low current)	8	BW9K1DG0	BW9K1DG0-R	–	–	
Auxiliary switch + Alarm switch	WK	BW9WKSG0	BW9WKSG0-R	BW9WKSG0-A	BW9WKSG0-RA	
Auxiliary switch + Alarm switch (low current)	18	BW9WKDG0	BW9WKDG0-R	–	–	
Shunt trip device	FR	BW9FRG0	BW9FRG0	–	BW9FRG0-RA	24V AC/DC
	FS	BW9FSG0	BW9FSG0		BW9FSG0-RA	48V AC/DC
	FA	BW9FAG0	BW9FAG0		BW9FAG0-RA	100-120V AC/100-110V DC
	F1	BW9F1G0	BW9F1G0		BW9F1G0-RA	120-130V AC
	FK	BW9FKG0	BW9FKG0		BW9FKG0-RA	200-240V AC/200-220V DC
	FB	BW9FBG0	BW9FBG0		BW9FBG0-RA	277V AC
	FP	BW9FPG0	BW9FPG0		BW9FPG0-RA	380-440V AC
	FH	BW9FHG0	BW9FHG0		BW9FHG0-RA	440-480V AC
	FJ	BW9FJG0	BW9FJG0		BW9FJG0-RA	500-550V AC
Undervoltage trip device	RR	BW9RGAR	–	–	–	24V DC
	RS	BW9RGAS				48V DC
	RL	BW9RGAL				100-110V DC
	R5	BW9RGA5				125V DC
	RA	BW9RGAA				100-110V AC
	RT	BW9RGAT				110-130V AC
	RK	BW9RGAK				200-240V AC
	RB	BW9RGAB				277V AC
	RP	BW9RGAP				380-415V AC
RH	BW9RGAH				440-480V AC	

400, 630, 800AF

Breaker type: BW400, EW400, BW630, EW630, BW800

Accessory	Code	Part number		Operating voltage
		Lead wire type		
		Left side	With terminal block type	
Auxiliary switch x 1	W	BW9W1SHA	BW9W1SHA-A	–
Auxiliary switch x 2	V	BW9W2SHA	–	
Auxiliary switch (low current) x 1	1	BW9W1DHA	–	
Auxiliary switch (low current) x 2	2	BW9W2DHA	–	
Alarm switch x 1	K	BW9K1SHA	BW9K1SHA-A	
Alarm switch x 2	J	BW9K2SHA	–	
Alarm switch (low current) x 1	8	BW9K1DHA	–	
Alarm switch (low current) x 2	9	BW9K2DHA	–	
Shunt trip device	FR	BW9FHA-R	BW9FHA-RA	24-48V AC/DC
	FA	BW9FHA-A	BW9FHA-AA	100-240V AC/100-220V DC
	FB	BW9FHA-B	BW9FHA-BA	277V AC
	FP	BW9FHA-P	BW9FHA-PA	380-550V AC
Undervoltage trip device	RR	BW9RHA-R	–	24V AC/DC
	RS	BW9RHA-S		48V AC/DC
	RA	BW9RHA-A		100-110 AC/DC
	R1	BW9RHA-1		120-130V AC/125V DC
	RK	BW9RHA-K		200-240V AC/200-220V DC
	RB	BW9RHA-B		277V AC
	RP	BW9RHA-P		380-480V AC

Internal Accessories for G-TWIN

Operation of auxiliary switches (W) and alarm switches (K)

Accessory	Handle position		
	ON	OFF	Trip
Auxiliary switch			
Alarm switch			

Note: Wire ring mark indication
 () Code of low current type

Operation of earth alarm switch (L)

Accessory	Handle position	
	ON/OFF/Overcurrent trip	EL trip
Earth alarm switch L		

Rating of auxiliary switches(W), alarm switches(K) and earth alarm switch(L)

Standard type

Breaker type	Rated thermal current (A)	Make/break current (A)						Minimum load current
		AC			DC			
		Voltage (V)	Res. load	Ind. load	Voltage (V)	Res. load	Ind. load	
BW125, BW250 BW400 BW630 BW800	5	24	5	5	24	4	3	5V DC 160mA 30V DC 30mA
EW125, EW250 EW400 EW630		48	5	5	48	2.5	1	
		125	5	3	125	0.4	0.4	
		250	3	2	250	0.2	0.2	

Low current type *1

Breaker type	Rated thermal current (A)	Make/break current (A)				Minimum load current
		AC		DC		
		Voltage (V)	Res. load	Voltage (V)	Res. load	
BW125, BW250 BW400 BW630 BW800 EW125, EW250 EW400, EW630	0.1	30	0.1	30	0.1	5V DC 1mA

*1 Low current type is NOT available for earth alarm switch

Internal Accessories for G-TWIN

Rating of shunt trip (F)

Breaker type	AC		DC		Time rating of coil	Opening time (ms)
	V	VA	V	W		
BW125, BW250 EW125, EW250	24	50	24	50	Continuous (With 1NO contact to prevent coil burn-out)	13-21
	48	50	48	50		
	100-120	50	100-110	50		
	120-130	50	-	-		
	200-240	50	200-220	50		
	277	50	-	-		
	380-440	50	-	-		
	440-480	50	-	-		
BW400, BW630, BW800 EW400, EW630	24-48	2	24-48	2	Continuous	8-20
	100-240	3	100-220	3		
	277	3	-	-		
	380-550	4	-	-		

Note: Allowable voltage function AC voltage: 85% to 110% of coil rated voltage
DC voltage: 75% to 125% of coil rated voltage

Rating of undervoltage trip (R)

Breaker type	AC		DC		Code
	V	VA	V	W	
BW125 *1	-	-	24	5	RR
BW250 *1	-	-	48	5	RS
EW125 *1	-	-	100-110	5	RL
EW250 *1	-	-	125	5	R5
	100-110	5	-	-	RA
	110-130	5	-	-	RT
	200-240	5	-	-	RK
	277	5	-	-	RB
	380-415	5	-	-	RP
	440-480	5	-	-	RH
BW400 *2	24	2	24	2	RR
EW400 *2	48	2	48	2	RS
BW630 *2	100-110	3	100-110	3	RA
EW630 *2	120-130	3	125	3	R1
BW800 *2	200-240	3	200-220	3	RK
	277	3	-	-	RB
	380-480	4	-	-	RP

Note: Allowable voltage function AC voltage: 85% to 110% of coil rated voltage
DC voltage: 75% to 125% of coil rated voltage

*1 Reset-allowed type: When the breaker handle is in the OFF or RESET state, tripping does not occur even if the R coil is not energized. Turning ON with the R coil not energized causes normal tripping.

*2 Reset-prohibited type: When the R coil is not energized, reset operation cannot reset the tripped breaker to the OFF state.

Lead wire specification









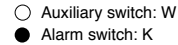
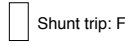
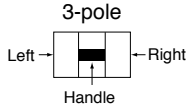
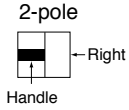





































Wire size: AWG20 (0.5mm²)

Wire length: 19.69 inch (500mm)

Internal Accessory Combinations for G-TWIN MCCB

Available configurations



MCCB	BW125JAGU-2P	BW125 BW250 (Except for BW125JAGU-2P)	BW400 BW630 BW800
Pole	2	2, 3	2, 3
Auxiliary switch SPDT: W (1)			
Alarm switch SPDT: K (8)			
Shunt trip: F			
Undervoltage trip: R			
W+K (1+8)			
Auxiliary switch 2PDT: V (2)			
Alarm switch 2PDT: J (9)			
V+K (2+8)			
W+J (1+9)			
V+J (2+9)			
W+F (1+F)			
W+R (1+R)			
K+F (8+F)			
K+R (8+R)			
W+K+F (1+8+F)			
W+K+R (1+8+R)			
V+F (2+F)			
V+R (2+R)			
J+F (9+F)			
J+R (9+R)			
V+K+F (2+8+F)			
V+K+R (2+8+R)			
W+J+F (1+9+F)			
W+J+R (1+9+R)			
V+J+F (2+9+F)			
V+J+R (2+9+R)			

Notes: • The above table is applied to front mounting type, rear mounting type, flush mounting type, and plug-in mounting type.
 • Terminal block is attached on the same side of the accessory.
 • () Code of low level circuit

Internal Accessory Combinations for G-TWIN ELCB

Available configurations

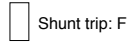
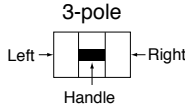
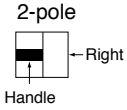

- Auxiliary switch: W
- Alarm switch: K
- ▲ Earth alarm switch: L (Factory-installed accessory)

ELCB	EW125 EW250	EW400 EW630
Pole	3	3
Auxiliary switch SPDT: W (1)		
Alarm switch SPDT: K (8)		
Shunt trip: F		
Undervoltage trip: R		
W+K (1+8)		
Auxiliary switch 2PDT: V (2)		
Alarm switch 2PDT: J (9)		
V+K (2+8)		
W+J (1+9)		
V+J (2+9)		
W+F (1+F)		
W+R (1+R)		
K+F (8+F)		
K+R (8+R)		
W+K+F (1+8+F)		
W+K+R (1+8+R)		
V+F (2+F)		
V+R (2+R)		
J+F (9+F)		
J+R (9+R)		
V+K+F (2+8+F)		
V+K+R (2+8+R)		
W+J+F (1+9+F)		
W+J+R (1+9+R)		
V+J+F (2+9+F)		
V+J+R (2+9+R)		
Earth alarm switch SPDT: L*1		

Notes: • The above table is applied to front mounting type, rear mounting type, flush mounting type, and plug-in mounting type.

• Terminal block is attached on the same side of the accessory.

• () Code of low level circuit

*1 Earth alarm switch can be mounted regardless of the combination of other accessories.

External Accessories

Operating handles

Conforms to EN60947-1 isolation function.
 Available for EN60204-1 power breaking device.
 Conforms to UL489(File No. E93289)

N type handles

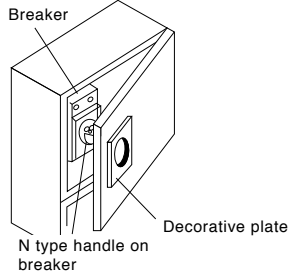

V type handles

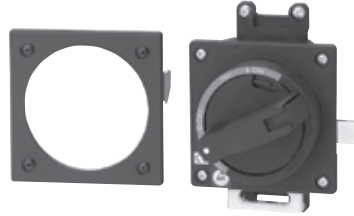
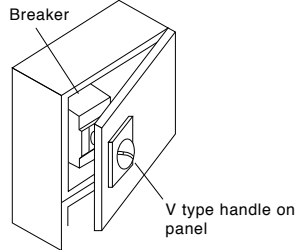

BW9N0CA
N type handle

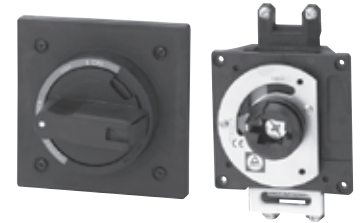

BW9V0CA
V type handle

Part number		Applicable Breakers
N type (Breaker mount)	V type (Door mount)	
BZ6N10D	BZ6V10D	BW50RAGU, BW100EAGU, EW50RAGU, EW100EAGU
BW9N0CA	BW9V0CA	BW125*1, EW125
BW9N0GA	BW9V0GA	BW250, EW250
BW9N0HA	BW9V0HA	BW400, EW400
BW9N0JA	BW9V0JA	BW630, EW630, BW800

*1 Note that the external operating handle cannot be mounted to the BW125JAGU-2P. Use the BW125RAGU-2P.

Terminal covers

These terminal covers are used as guards to prevent accidental touch with live line terminations.
 These terminal covers can be fitted to either line or load side.



Short type



Long type

Short type

Black	Transparent	Gray-White	Packing QTY	Applicable Breakers
-	BW9BTAA-S2	BW9BTAA-S2W*1	2	BW50RAGU-2P, BW100EAGU-2P
-	BW9BTAA-S3	BW9BTAA-S3W*1	2	BW50RAGU-3P, BW100EAGU-3P, EW50RAGU-3P, EW100EAGU
-	BW9BTCA-S2	BW9BTCA-S2W*1	2	BW125JAGU-2P
-	BW9BTCA-S3	BW9BTCA-S3W*1	2	BW125JAGU-3P, EW125*U-3P
-	BW9BTGA-S3	BW9BTGA-S3W*1	2	BW250*U-2P, BW250*U-3P, EW250*U-3P
-	BW9BTHA-S3*2	BW9BTHA-S3W*2	2	BW400*U-2P, BW400*U-3P, EW400*U-3P

Notes: *1 Gray-white short type terminal covers are provided with breaker as standard for 50AF, 100AF, 125AF and 250AF G-TWIN breakers.

*2 Not available with Flat terminal.

Long type

Black	Transparent	Gray-White	Packing QTY	Applicable Breakers
-	BW9BTAA-L2	BW9BTAA-L2W	2	BW50RAGU-2P, BW100EAGU-2P
-	BW9BTAA-L3	BW9BTAA-L3W	2	BW50RAGU-3P, BW100EAGU-3P, EW50RAGU-3P, EW100EAGU
-	BW9BTCA-L2	BW9BTCA-L2W	2	BW125JAGU-2P
-	BW9BTCA-L3	BW9BTCA-L3W	2	BW125*U-3P, EW125*U-3P
-	BW9BTGA-L3	BW9BTGA-L3W	2	BW250*U-2P, BW250*U-3P, EW250*U-3P
-	BW9BTHA-L3	BW9BTHA-L3W	2	BW400*U-2P, BW400*U-3P, EW400*U-3P
-	BW9BTJA-L3	BW9BTJA-L3W	2	BW630*U-3P, EW630*U-3P, BW800*U-3P

External Accessories

Insulation barriers

The barriers are installed in the molded slots between terminals. Installation of these barriers after wiring is possible even when an external accessory is installed.



Insulation barriers		Applicable Breakers
Type	Packing quantity	
BZ6B10C	4	BW50RAGU, BW100EAGU, EW50RAGU, EW100EAGU*1
BW9BPCA	4	BW125, EW125*2
BW9BPGA	4	BW250, EW250*2
B-43A	4	BW400, EW400, BW630, EW630, BW800*2

Note:*1 Insulation Barriers are required only for flat terminal type.

*2 Insulation Barriers for line side and load side are provided with the Breaker.

Terminal kits (Field installable)

Flat Terminal Kits		Lug Terminal Kits		Applicable Breakers
Type	Packing quantity	Type	Packing quantity	
BZ-SU20B	3	-	-	BW50RAGU, EW50RAGU
BZ-SU25B	3	-	-	BW100EAGU, EW100EAGU
BW9SS0CA-3 GLOBAL	3	BW9SL0CA-3 GLOBAL	3	BW125, EW125
BZ-S50B-2253 GLOBAL	3	BW9SL0GA-3 GLOBAL	3	BW250, EW250 (125A-175A)
		BW9SL1GA-3 GLOBAL	3	BW250, EW250 (200A-250A)

Padlocking device and Handle locking cover (Non UL items)

● Description

• Padlocking device

These padlocking devices lock the breaker handle in the OFF position.

Use a commercially available padlock with a shackle diameter of 3.5 to 5mm (5mm for the BZ6L10CA).

• Handle locking cover

These padlocking devices lock the breaker handle in the ON/OFF position.

Tripping is possible while the breaker is locked ON.

Applicable Breakers	Padlocking device		Handle locking cover
	Q1, QN: Cap type	Q2: Plate type	
BW50, BW100, EW50, EW100	BZ6L10CA	Not available	BZ6L10C*1 (Non-UL)
BW125, EW125	BW9Q1CA	BW9Q2CA	Not available
BW250, EW250	BW9Q1CA	BW9Q2GA	Not available
BW400, EW400	BW9QNHA*1	BW9Q2HA	Not available
BW630, EW630, BW800	BW9QNHA*1	BW9Q2JA	Not available

*1 ON and OFF locking is possible

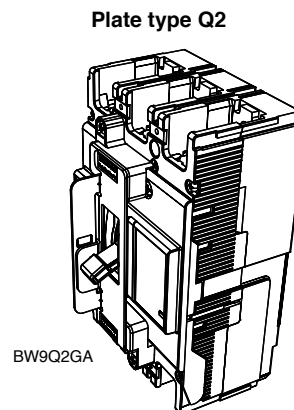
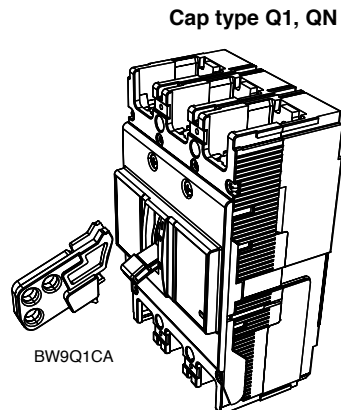

Operating Handles Dimensions: inch (mm)

50A,100A Frame N type handle (BZ6NP1D: dust proof packing, optional)

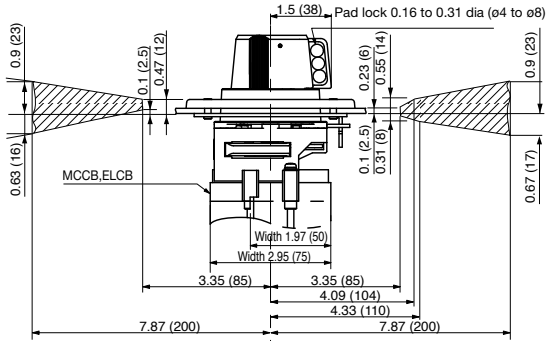
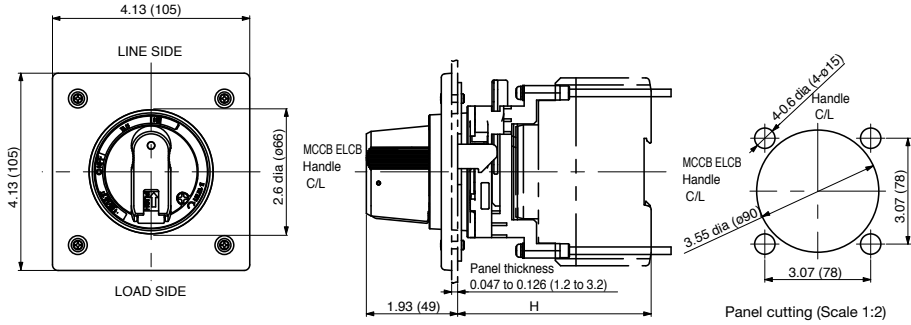

Install the door hinge in the shaded area

Breaker type	Handle type	H: inch(mm)	Mounting screw	Mass lb. (kg)
BW50RAGU	BZ6N10D	4.055±0.078	#8-32×3.149	1.04
EW50RAGU		(103±2)	(M4×80)	(0.47)
BW100EAGU				
EW100EAGU				

Note: • The handle cannot hold the enclosure door.
 • Not available for side mounting.
 • When using a Dust-proof packing, handle protection degree is IP 50 (IEC60529).

50A,100A Frame V type handle (BZ6VS1D: optional shaft)

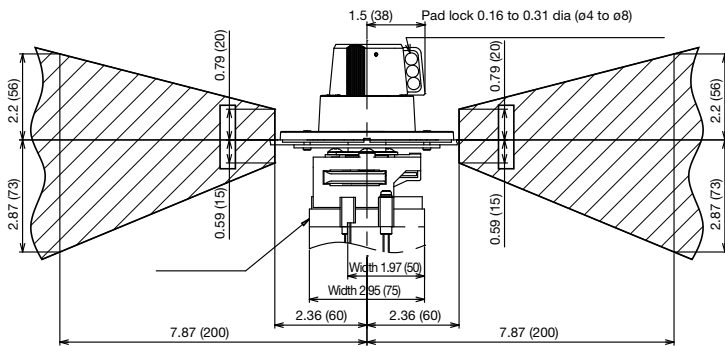
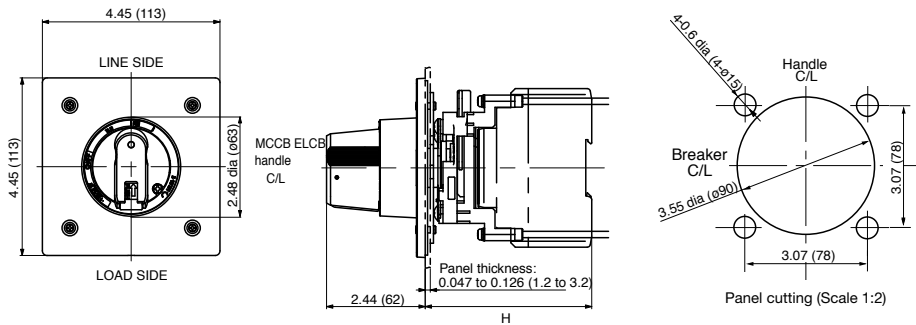

Install the door hinge in the shaded area.

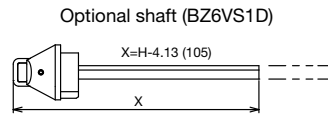

When using the BZ6VS1D optional shaft to adjust dimension H(5.590 to 9.842), cut it according to the equation below.
 $X = H - 4.13(105)$

Breaker type	Handle type	Standard type H: inch(mm)	With the optional shaft BZ6VS1D		Mounting screw	Mass lb. (kg)
			X=6.102(155) H:inch(mm)	Area in which the hinge with H can be installed		
BW50RAGU	BZ6V10D	4.134±0.078	9.842±0.078	5.590 to 9.842	#8-32×3.149	1.41
EW50RAGU		(105±2)	(250±2)	(142 to 250)	(M4×80)	(0.64)
BW100EAGU						
EW100EAGU						

Note: • The handle cannot hold the enclosure door.
 • Not available for side mounting.
 • Handle protection degree is IP 54 (IEC60529, JIS C0920).

Operating Handles Dimensions: inch (mm)

125A, 250A Frame N type handle

- BW9N0CA, BW9N0GA (BZ-NP-1C: dust proof packing, optional)

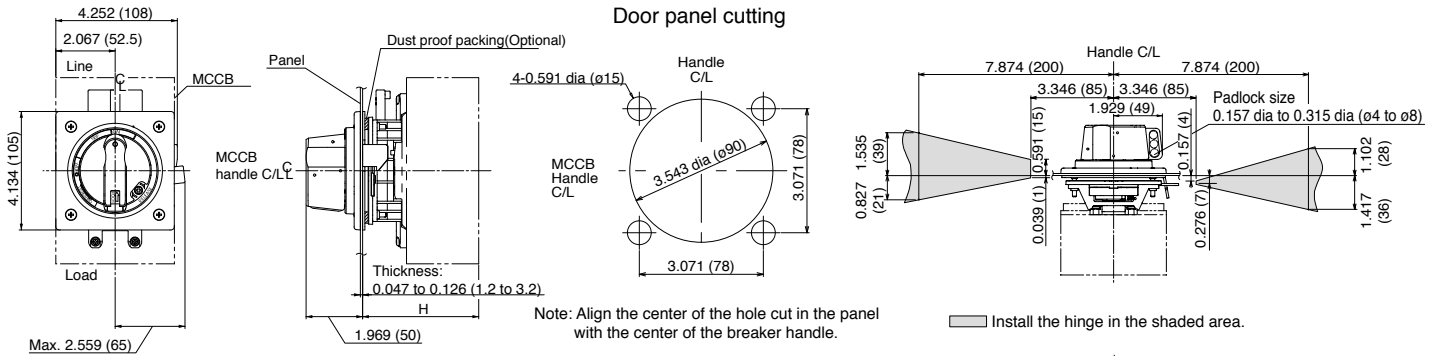

Breaker type	Handle type	H: inch(mm)	Mounting screw	Mass lb. (kg)
BW125	BW9N0CA	4.055±0.078	#8-32×3.346	1.23
EW125	BW9N0GA	103±2	(M4×85)	(0.56)
BW250				
EW250				

- Note:
- The handle cannot hold the enclosure door.
 - Not available for side mounting.
 - When using a Dust-proof packing, Handle protection degree is IP 50 (IEC60529).

400A, 630A, 800A Frame N type handle

- BW9N0HA, BW9N0JA (BZ-NP-2: dust proof packing, optional)

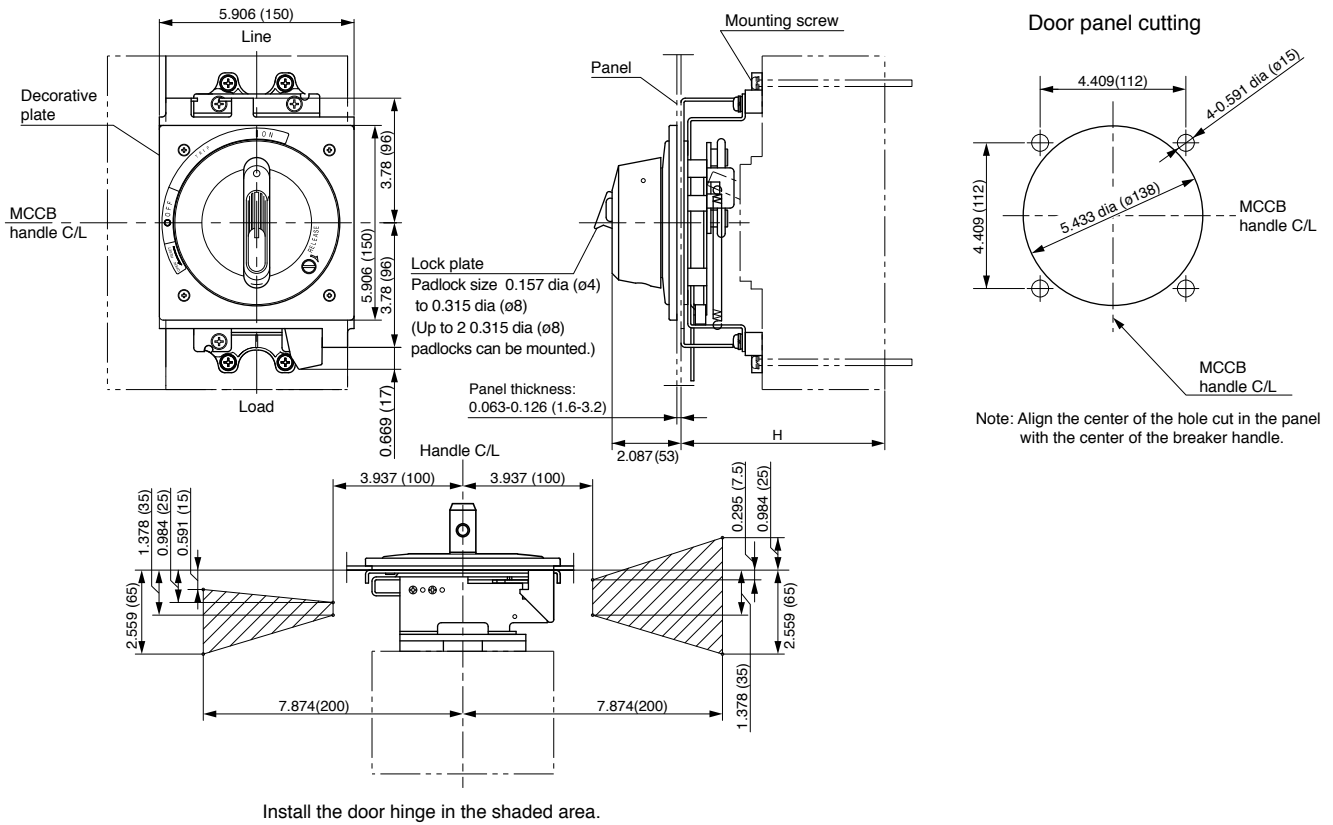

Breaker type	Handle type	H: inch(mm)	Mounting screw	Mass lb. (kg)
BW400	BW9N0HA	6.181±0.078	1/4-20×4.331	4.19
EW400	BW9N0JA	157±2	(M6×110)	(1.90)
BW630, BW800				
EW630				

- Note:
- The handle cannot hold the enclosure door.
 - Not available for side mounting.
 - When using a Dust-proof packing, Handle protection degree is IP 50 (IEC60529).

Operating Handles Dimensions: inch (mm)

125A, 250A Frame V type handle

• BW9V0CA, BW9V0GA (BW9VSG0: optional shaft)

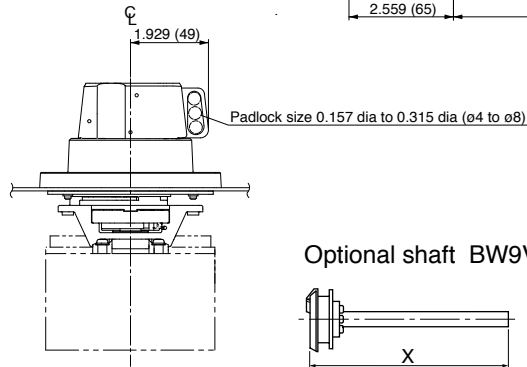
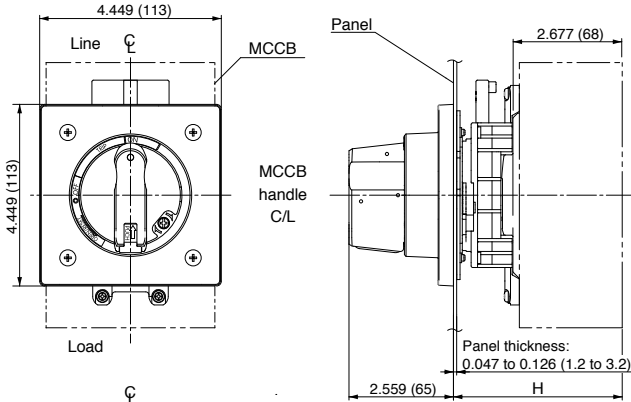

Optional shaft BW9VSG0

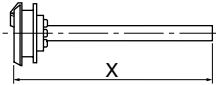

When using the BW9VSG0 optional shaft to adjust dimension H (5.590 to 9.842), cut it according to the equation below.
 $X = H - 3.740(95)$

Door panel cutting

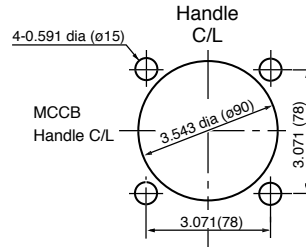

Note: Align the center of the hole cut in the panel with the center of the breaker handle.

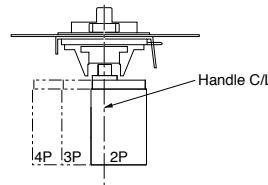

Door hinge installation area

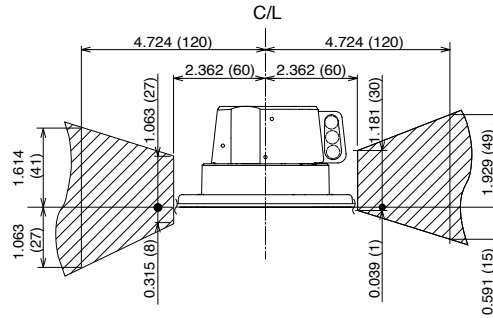

Install the door hinge in the shaded area.

Breaker type	Handle type	Standard type H: inch(mm)	With the optional shaft BW9VSG0		Mounting screw	Mass lb. (kg)
			X=6.102(155) H: inch(mm)	Area in which the hinge with H can be installed		
BW125 EW125	BW9V0CA*1	4.134±0.078 (105±2)	9.842±0.078 (250±2)	5.590 to 9.842 (142 to 250)	#8-32x3.346 M4 x 85	1.48 (0.67)
BW250 EW250	BW9V0GA*2					

Notes:

- The handle cannot hold the enclosure door.
- Not available for side mounting.
- Handle protection degree is IP 54 (IEC60529, JIS C0920).
- *1 Note that the external operating handle cannot be mounted to the BW125JAGU-2P. Use the BW125RAGU-2P.
- *2 When mounting a terminal cover, cut away part of it because it hides the mounting screws for the breaker.
Remove the shaded parts in the figure below.

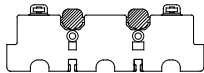

Operating Handles Dimensions: inch (mm)

400A, 630A, 800A Frame V type handle

• BW9V0HA, BW9V0JA (BZ-VS2: optional shaft)

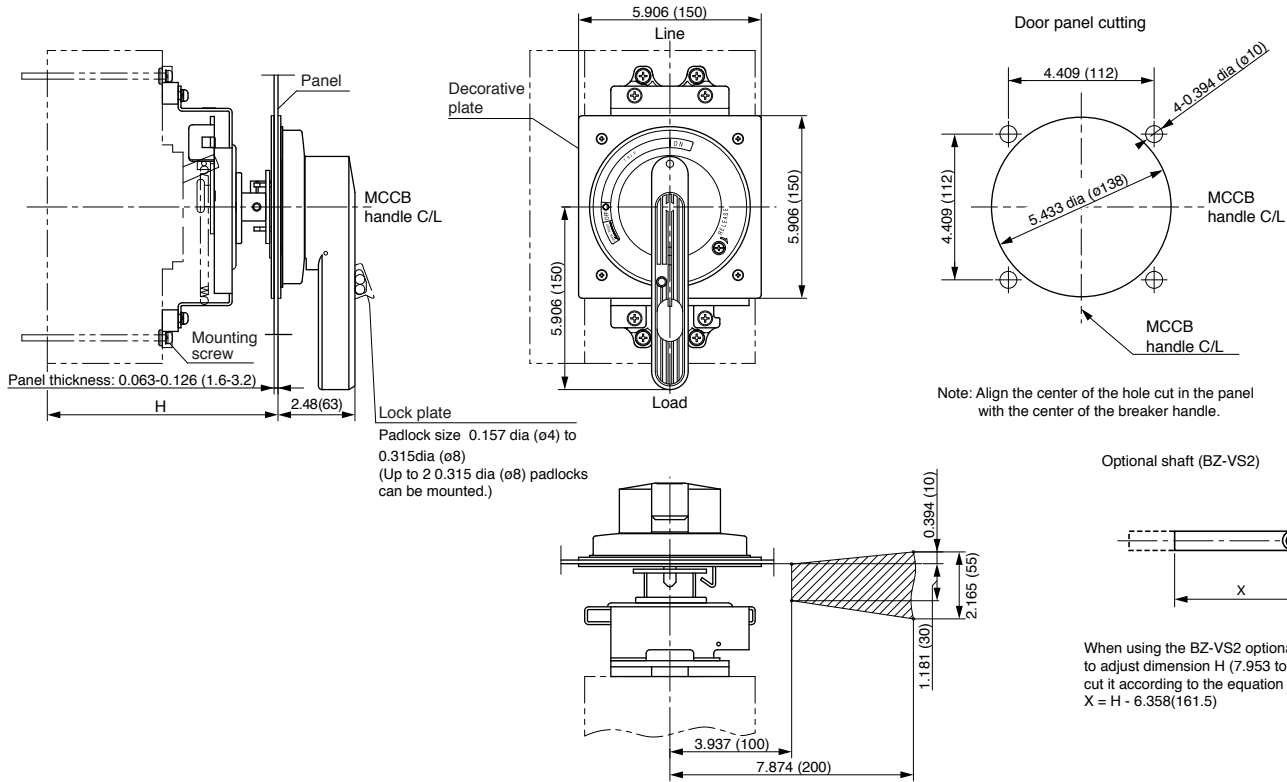

Install the door hinge in the shaded area.

Breaker type	Handle type	Standard type H: inch(mm)	With the optional shaft BZ-VS2 X=3.504(89)		Mounting screw	Mass lb. (kg)
			H: inch(mm)	Area in which the hinge with H can be installed		
BW400 EW400	BW9V0HA	7.48±0.078 (190±2)	9.842±0.078 (250±2)	7.953 to 9.842 (202 to 250)	1/4-20X4.331 (M6X110)	4.85 (2.2)
BW630, BW800 EW630	BW9V0JA					

Note: • The handle cannot hold the enclosure door.
• Not available for side mounting.
• Handle protection degree is IP 54 (IEC60529, JIS C0920).

Wiring

1. Connecting Precautions

- When connecting the wires, follow the instruction of NEC (National Electric Code, USA) or CEC (Canadian Electrical code Part 1, Canada).
- For connecting, use copper wire rated for 75°C. It is recommended to use UL or CSA approved wires.
- Keep the connection of the wire sufficiently tight, because a very large electromagnetic force will be generated, when the short circuit current is applied.
- Perform additional tightening of the terminal screws periodically.

2. Terminal Construction

	Screw Terminals	Flat Terminals	Lug Terminals
50A, 100A Frame	●	●	—
125A, 250A Frame	●	●	●
400A, 630A, 800A Frame	—	●	●

● : Available — : Not available

3. Allowable wire spec for Lug Terminals

Number of strands connecting wires

Wire size AWG or MCM (mm ²)	Number of wires strands
14 – 2 (2.1 – 33.6)	7
1 – 4/0 (42.4 – 107.2)	19
250 – 500 (127 – 250)	37

(mm²) Values are those converted from AWG or MCM size

⚠ Caution

- Two wires cannot be connected together to a single connecting hole of lug terminal except BW400SAGU-3P400SB.
- Follow the number of strands of wire indicated on the table.
(Wire size and number of wire strands not listed on table can not be connected)
- Do not solder the end of the wire.



Rated current 15A to 350A



Rated current 400A
3/0 AWG x 2
19 strands each



Rated current 500A to 700A



Rated current 800A
300 MCM x 3
37 strands each

Max Wire Sizes and Tightening Torque

Type	Rated current (A)	Wire size*2 AWG or MCM (mm ²)	Tightening torque			Applicable ring (crimp) terminal for screw type and flat type terminal breaker*1								
			Screw terminal	Flat terminal	Lug terminal	JST (UL file No.E42024)	NICHIFU (UL file No.E44245)	DST (UL file No.E74917)						
BW50RAGU EW50RAGU	3	14 AWG (2.1mm ²)	20-25 lb.-In. (2.3-2.8 N-m)	31-40 lb.-in. (3.5-4.5 N-m)	-	R2-5	R2-5M R2-5	2-S5, 2-5						
	5	14 AWG (2.1mm ²)				R5.5-5	R3.5-5S, R3.5-5L 5.5-6N, R5.5-5S, R5.5-5	3.5-5, 5.5-S5, 5.5-5, 5.5-L5						
	10	14 AWG (2.1mm ²)												
	15	14 AWG (2.1mm ²)												
	20	12 AWG (3.3mm ²)												
	30	10 AWG (5.3mm ²)												
	40	8 AWG (8.4mm ²)												
50	8 AWG (8.4mm ²)	49-66 lb.-In. (5.5-7.5 N-m)	71-89 lb.-In. (8-10 N-m)	51 lb. - In. (5.8 N-m)	R14-8	R14-8S, R14-8	R14-S8, R14-8							
60	6 AWG (13.3mm ²)				R22-S8, R22-8 R38-S8	R22-8S, R22-8 R38-8S	R22-S8, 22-8 38-S8							
75	4 AWG (21.1mm ²)													
100	3 AWG (26.7mm ²)													
BW125 EW125	15							14 AWG (2.1mm ²)	51 lb. - In. (5.8 N-m)	51 lb. - In. (5.8 N-m)	51 lb. - In. (5.8 N-m)	R2-8	R2-8	2-8, 2-B8
	20							12 AWG (3.3mm ²)				5.5-S8, R5.5-8	R3.5-8, R5.5-8 R5.5-8 R8-8	3.5-8, 5.5-8 5.5-8 8-8
	30							10 AWG (5.3mm ²)						
	40	8 AWG (8.4mm ²)												
	50													
	60	6 AWG (13.3mm ²)	14-8NS, 14-S8, R14-8	R14-8S, R14-8	14-S8, 14-8									
	70	4 AWG (21.1mm ²)				22-S8, R22-8, CB22-S8	R22-8S, R22-8, CB22-8S	22-S8, 22-8, CB22-8						
	75													
	80													
	90	3 AWG (26.7mm ²)	38-S8	R38-8S	38-S8									
100														
125	1 AWG (42.4mm ²)													
BW250 EW250	125	1 AWG (42.4mm ²)	93 lb. - In. (10.5 N-m)	93 lb. - In. (10.5 N-m)	204 lb. - In. (23 N-m)	38-S8, R38-8	R38-S, R38-8	38-S8, 38-8						
	150	1/0 AWG (53.5mm ²)				60-S8, R60-8	R60-8, CB60-8, CB60-8S	60-8, CB60-8						
	175	2/0 AWG (67.4mm ²)												
	200	3/0 AWG (85.0mm ²)												
	225	4/0 AWG (107.2mm ²)												
	250	250 MCM (127mm ²)												
BW400 EW400	250	250 MCM (127mm ²)	-	385 lb. - In. (43.5 N-m)	385 lb. - In. (43.5 N-m)	150-12	R150-12	-						
	300	350 MCM (177mm ²)				180-12	R180-12	-						
	350	500 MCM (253mm ²)												
	400	3/0 AWG x 2 (85.0mm ² x 2)							262 lb. - In. (31.9 N-m)	R80-12	R80-12			
		500 MCM (253mm ²)										325-12	R325-12N	-
BW630 EW630	500	250 MCM x 2	-	416 lb. - In. (47.1 N-m)	275 lb. - In. (31.1 N-m)	R150-12	R150-12	-						
	600	350 MCM x 2				180-12	R180-12	-						
	630	500 MCM x 2							325-12	R325-12N	-			
BW800	700	500 MCM x 2	-	416 lb. - In. (47.1 N-m)	275 lb. - In. (31.1 N-m)	325-12	R325-12N	-						
	800	300 MCM x 3				-	-	-	-	-				

Notes: *1 Ring (Crimp) Terminal Manufacturer : JST=Japan Solderless Terminal MFG Co., Ltd. (<http://www.jst.com>)
NICHIFU=Nichifu Terminal Co., Ltd. (america@nichifu.com)
DST=Daido Solderless Terminal MFG Co., Ltd. (info@daido-tanshi.jp)

*2 167°F (75°C) Copper wire

Flange Disconnect Handle <F Type Handle>

Features

- Flexible cable operation.
- Covering up to 400-amp frame size.
- Easy installation on circuit breakers.
- Complies with NEMA type 12, IP 54 protection degree.
- Accepts ANSI standard American padlock devices.
- Off lockable: 0.394 dia (ϕ 10) padlock device, Max 3 pieces.
- UL listed product. [UL489, File No. E93289]

Ordering information

- Main unit and cable are minimum required for assembling.
- Select cable with main unit using below table.
- Ex: BW9F0CA, BW9FWCA-15A

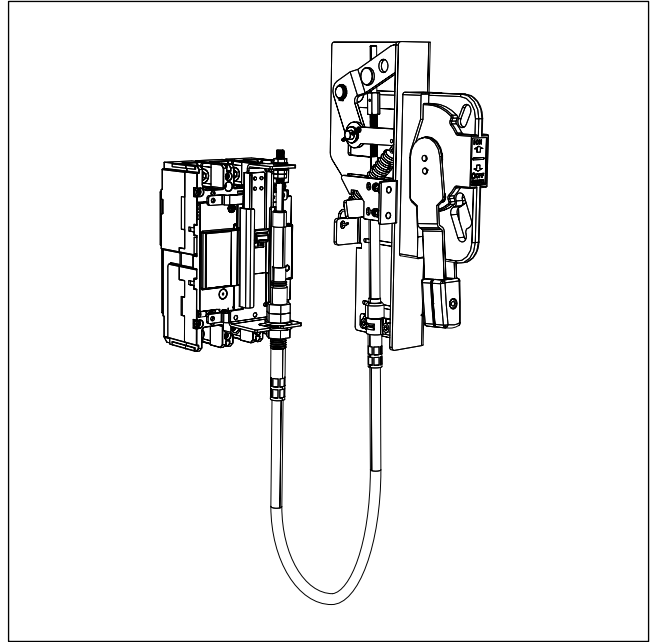

Specifications

Applicable breaker frame size		125 amp frame	250 amp frame	400 amp frame	630/800 amp frame
Part numbers	Main unit	BW9F0CA (Not include cable)	BW9F0GA (Not include cable)	BW9F0HA (Not include cable)	BW9F0JA (Not include cable)
	Terminal cover*2	BW9FBTCA-L3	BW9FBTGA-L3	BW9FBTHA-L3	BW9FBTJA-L3
	Cable 59.06 inch (1.5m)	BW9FWCA-15A	BW9FWGA-15A	BW9FWHA-15A	BW9FWHA-15A
	Cable 78.74 inch (2.0m)	BW9FWCA-20A	BW9FWGA-20A	BW9FWHA-20A	BW9FWHA-20A
	Cable 118.11 inch (3.0m)	BW9FWCA-30A	BW9FWGA-30A	BW9FWHA-30A	BW9FWHA-30A
Applicable breakers	MCCB	BW125JAGU*1 BW125RAGU	BW250EAGU BW250JAGU BW250RAGU	BW400EAGU BW400SAGU BW400RAGU BW400HAGU	BW630RAGU BW630HAGU BW800RAGU BW800HAGU
	ELCB	EW125JAGU EW125RAGU	EW250JAGU EW250RAGU	EW400SAGU EW400RAGU	EW630RAGU
Operating instructions		<ul style="list-style-type: none"> - Operating handle facing up, Breaker is in ON position. - Operating handle facing down, Breaker is in OFF position or is reset. - Panel door cannot be opened when in ON, OFF or Trip position. In order to open the door, the handle must be turned toward reset position. - Release screw is standard. If you want to open a panel door in ON position, please turn on the release screw using flat head screwdriver. 			
Mechanical endurance (cycles)		10,000	8,000	6,000	
Ambient temperature		14 to 140F (- 10 to 40°C)			
Relative humidity		less than 95% RH			
Protection		NEMA Type12 IP54 (IEC60529)			
Conforming standards		NFPA 79(2007), ANSI(Lockout), OSHA(1910.147, Lockout/tagout), UL489(cUL)			
Atmosphere		No excessive dust, smoke, corrosive gases, flammable gases, steam or salt.			

Note: *1 Not available for BW125JAGU-2P

*2 Standards terminal cover in page 27 can not use with Flange Disconnect Handle

Flange Disconnect Handle <F Type Handle>

Dimensions: inch (mm)

• BW9F0HA

Drive section

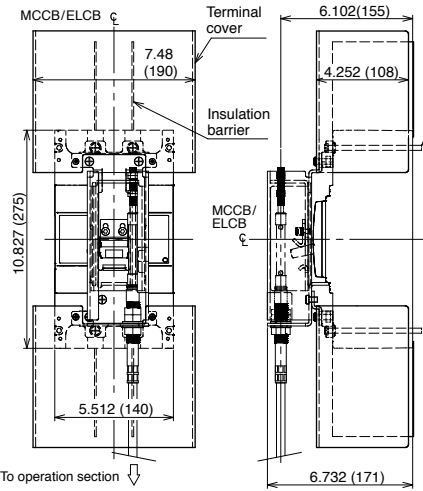

Operation section

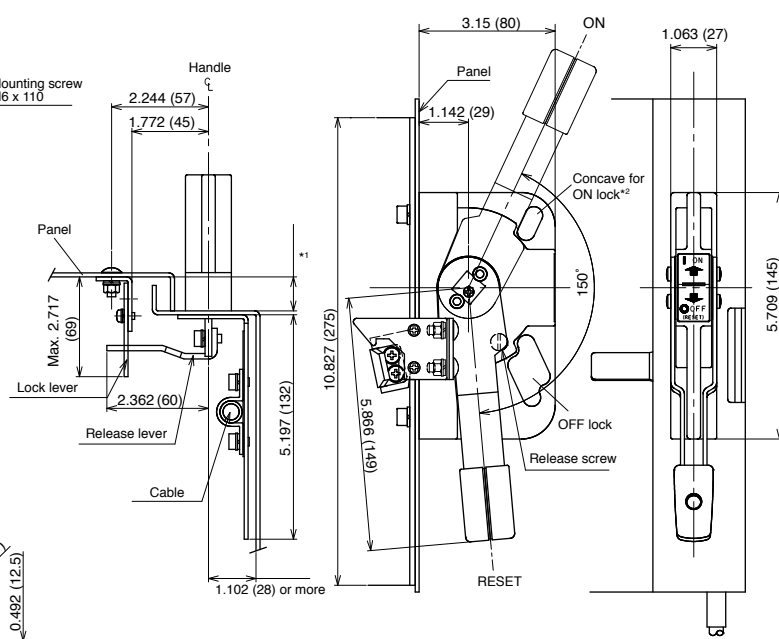

To operation section

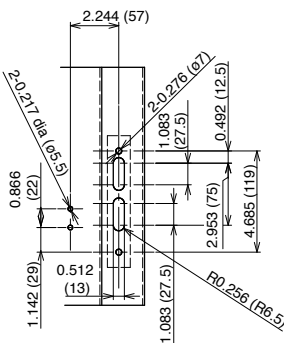
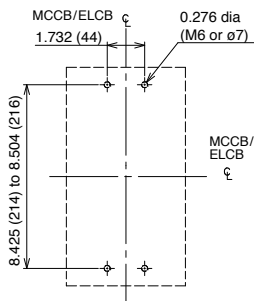

Panel drilling

- This product consists of a drive section and an operation section.
- The operation section can be mounted either to the right or to the left on the panel depending on the mounting position of the release lever.
- For the OFF lock, 3 0.394 dia (ϕ 10) padlocks can be mounted; for the ON lock, 2 0.394 dia (ϕ 10) padlocks.
- *1 Set the height to 20mm or 30mm. Adjust the lock lever depending on the setting.
- *2 The ON lock can be realized by additionally creating a concave for the ON lock.

• BW9F0JA

Drive section

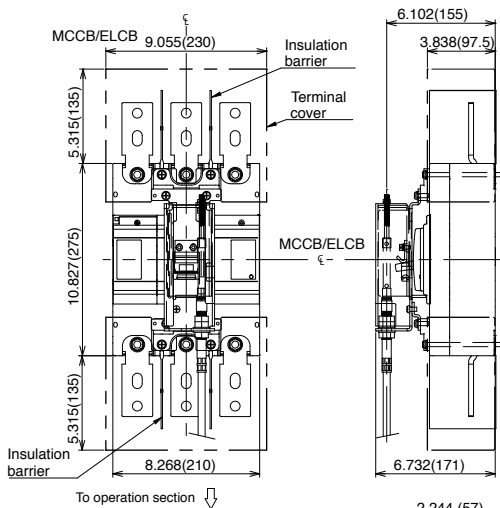

Operation section

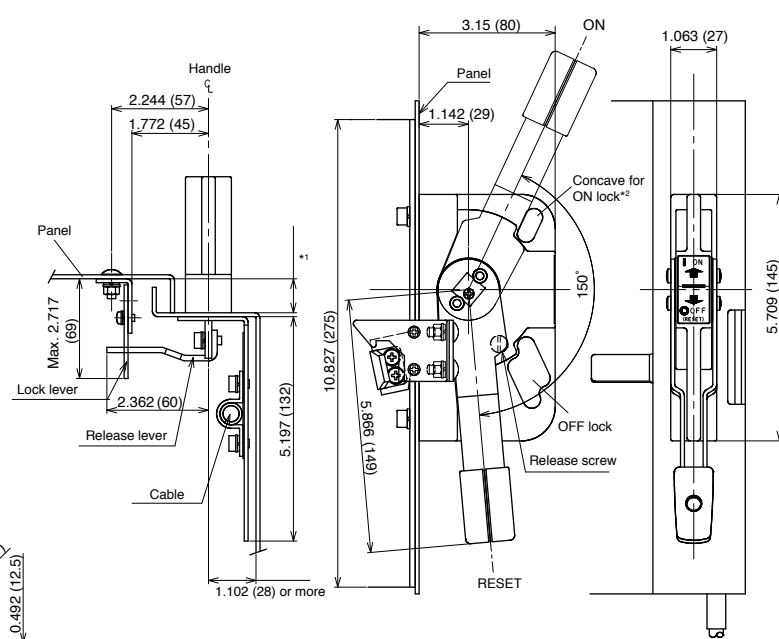

To operation section

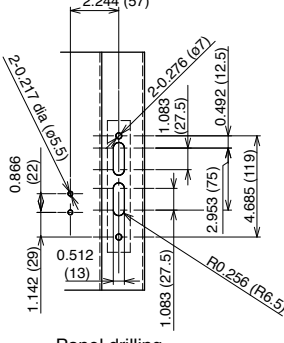
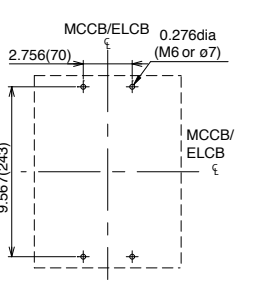

Panel drilling

- This product consists of a drive section and an operation section.
- The operation section can be mounted either to the right or to the left on the panel depending on the mounting position of the release lever.
- For the OFF lock, 3 0.394 dia (ϕ 10) padlocks can be mounted; for the ON lock, 2 0.394 dia (ϕ 10) padlocks.
- *1 Set the height to 20mm or 30mm. Adjust the lock lever depending on the setting.
- *2 The ON lock can be realized by additionally creating a concave for the ON lock.

Discontinued Products Cross Charts

Discontinue date : March 1989~December 2010

Series	Frame size		Molded Case Circuit Breakers		Earth Leakage Circuit Breakers	
			Discontinued Models	Replacement - UL489 (Non-UL)	Discontinued Models ^{*1}	Replacement - UL489 (Non-UL)
E series Non-UL	30AF	2 poles	EA32	BW50RAGU-2P	EG32F / EG32A	(EW32AAG-2P)
		3 poles	EA33	BW50RAGU-3P	EG33F / EG33A / EG33B	EW50RAGU-3P
	50AF	2 poles	EA52A	BW50RAGU-2P	EG52F	(EW50AAG-2P)
			EA52B	BW50RAGU-2P	EGa52A	(EW50AAG-2P)
		3 poles	EA53A	BW50RAGU-3P	EG53F / EG53A / EG53AH	EW50RAGU-3P
			EA53B	BW50RAGU-3P	EG53B	EW50RAGU-3P
	60AF	2 poles	EA62B	BW100EAGU-2P		
		3 poles	EA63B	BW100EAGU-3P	EG63A / EG63AH / EG63B	EW100EAGU-3P
	100AF	2 poles	EA102A / EA102B	BW100EAGU-2P	EG102A / EG102B	EW100EAGU-2P
			EA102H	BW125JAGU-2P	-	-
		3 poles	EA103F	BW100EAGU-3P	EG103F / EG103A / EG103B	EW100EAGU-3P
			EA103A / EA103B	BW100EAGU-3P	EG103AD / EG103BD	EW125JAGU-3P
			EA103H / EA103K	BW125JAGU-3P	EG103K	EW100EAGU-3P
		4 poles	EA104B	(BW125JAG-4P)	SGa104A(D)	(EW125JAG-4P)
	225AF	2 poles	EA202A / EA202B / EA202C	BW250EAGU-2P	-	-
			EA202H	BW250JAGU-2P	-	-
		3 poles	EA203A / EA203B / EA203C	BW250EAGU-3P	EGa203A(D)/EG203B(D)/EG203C(D)	EW250JAGU-3P
			EA203H	BW250JAGU-3P	-	-
	400AF	2 poles	EA402A / EA402B / EA402C	BW400EAGU-2P	-	-
		3 poles	EA403A / EA403B / EA403C	BW400EAGU-3P	EGa403A(D)/EG403B(D)/EG403C(D)	EW400SAGU-3P
600AF	3 poles	EA603A / EA603B / EA603C	BW630RAGU-3P	EGa603A(D)/EG603B(D)/EG603C(D)	EW630RAGU-3P	
800AF	3 poles	EA803A / EA803B / EA803C	BW800RAGU-3P	EGa803A(D)/EG803B(D)/EG803C(D)	(EW800EAG-3P)	
UL508	30AF	2 poles	EA32AC	BW50RAGU-2P	EG32AC	(EW32AAG-2P)
		3 poles	EA33AC	BW50RAGU-3P	EG33AC / EG33C	EW50RAGU-3P
	50AF	2 poles	EA52BUL / EA52AC / EA52C	BW50RAGU-2P	EG52AC	(EW50AAG-2P)
		3 poles	EA53BUL / EA53AC / EA53C	BW50RAGU-3P	EG53AC / EG53C	EW50RAGU-3P
	60AF	2 poles	EA62C	BW100EAGU-2P	-	-
		3 poles	EA63C	BW100EAGU-3P	EG63C	EW100EAGU-3P
	100AF	2 poles	EA102C	BW100EAGU-2P	EG102C	EW100EAGU-2P
		3 poles	EA103BUL / EA103AC / EA103C	BW100EAGU-3P	EG103AC / EG103C	EW100EAGU-3P
			-	-	EG103CD	EW125JAGU-3P
	UL489	100AF	2 poles	EA102CUL	BW100EAGU-2P	EG102CUL
3 poles			EA103CUL	BW100EAGU-3P	EG103CUL	EW100EAGU-3P
S series Non-UL	30AF	2 poles	SA32B	BW50RAGU-2P	-	-
		3 poles	SA33B	BW50RAGU-3P	SG33 / SG33A / SG33B	EW50RAGU-3P
	50AF	2 poles	SA52B / SA52R	BW50RAGU-2P	-	-
			SA52H	(BW50HAG-2P)	-	-
		3 poles	SA53B / SA53R	BW50RAGU-3P	SG53 / SG53A / SG53B / SG53R	EW50RAGU-3P
			SA53H	(BW50HAG-3P)	-	-
	4 poles	SA54B	(BW125JAG-4P)			
	60AF	2 poles	A62B / SA62B / SA62R	BW100EAGU-2P	-	-
		3 poles	SA63 / SA63B / SA63R	BW100EAGU-3P	SG63 / SG63A / SG63B / SG63R	EW100EAGU-3P
	100AF	2 poles	SA102A / SA102B / SA102C	BW125JAGU-2P	-	-
			SA102H / SA102R / SA102RC	BW125RAGU-2P	-	-
			SA102BA	BW125JAGU-2P	-	-
			SA102RA	BW125RAGU-2P	-	-
			SA102K	BW125JAGU-2P	-	-
		3 poles	SA103A / SA103B / SA103BA	BW125JAGU-3P	SGa103A(D) / SG103B(D)	EW125JAGU-3P
			SA103C		SG103C(D)	
			SA103H / SA103R / SA103RA	BW125RAGU-3P	SG103H(D) / SG103R(D)	EW125RAGU-3P
			SA103RC		SG103RC(D)	
			SA103BN/SA103BAN/SA103CN	-	SG103BA(D)	EW125JAGU-3P
			SA103RN/SA103RAN/SA103RCN	-	SG103RA(D)	EW125RAGU-3P
		4 poles	SA103K	BW125JAGU-3P	-	-
			SA104A	(BW125JAG-4P)	-	-
			SA104H / SA104R	(BW125RAG-4P)	SGa104H(D)	(EW125RAG-4P)
	225AF	2 poles	SA202A / SA202B / SA202C	BW250JAGU-2P	-	-
			SA202H / SA202R / SA202RC	BW250RAGU-2P	-	-
			SA202BA	BW250JAGU-2P	-	-
			SA202RA	BW250RAGU-2P	-	-
			SA202K	BW250EAGU-2P	-	-

Note: All accessories discontinued as well.

- : No replacement

*1: Discontinued Non-UL ELCB has a Trip Lead type, specify "TL" for P/N (Two lead wire comes from inside of the ELCB and labeled as TL1 & TL2). Replacement model P/N specify "T".

Ex: EG33AC/20-30MA-TL → EW32AAG-3P020B T

Discontinued Products Cross Charts

Discontinued date : March 1989~December 2010

Series	Frame size		Molded Case Circuit Breakers		Earth Leakage Circuit Breakers	
			Discontinued Models	Replacement - UL489 (Non-UL)	Discontinued Models*1	Replacement - UL489 (Non-UL)
H series Non-UL	50AF	2 poles	H52BA / H52C	(BW50HAG-2P)	-	-
		3 poles	H53BA / H53C	(BW50HAG-3P)	HG53B(D)	(EW50HAG-3P)
			H53BAN / H53CN	-	-	-
			H53CM	-	-	-
	100AF	2 poles	H102BA / H102C	(BW125HAG-2P)	-	-
		3 poles	H103BA / H103C	(BW125HAG-3P)	HG103B(D)	(EW125HAG-3P)
			H103BAN / H103CN	-	HG103BN(D)	-
	225AF	2 poles	H202BA / H202C	(BW250HAG-2P)	-	-
		3 poles	H203BA / H203C	(BW250HAG-3P)	HG203B(D)	(EW250HAG-3P)
			H203BAN / H203CN	(BX250HAE-3P)	HG203BN(D)	(EW250HAE-3P)
	400AF	2 poles	H402B / H402C	BW400HAGU-2P	-	-
			H402BN / H402CN	(BW400HAA-2P)	-	-
		3 poles	H403B / H403C	BW400HAGU-3P	HG403B(D) / HG403C(D)	EW400HAGU-3P
			H403BN/H403CN	(BW400HAA-3P)	HG403BN(D) / HG403CN(D)	-
600AF	3 poles	H603B / H603C	BW630HAGU-3P	HG603B(D) / HG603C(D)	(EW630HAG-3P)	
		H603BN / H603CN	(BW630HAA-3P)	HG603BN(D) / HG603CN(D)	-	
800AF	3 poles	H803B / H803C	BW800HAGU-3P	HG803B(D) / HG803C(D)	(EW800HAG-3P)	
		H803BN / H803CN	(BW800HAA-3P)	HG803BN(D) / HG803CN(D)	-	

Note; All accessories discontinued as well.

- : No replacement

*1: Discontinued Non-UL ELCB has a Trip Lead type, specify "TL" for P/N (Two lead wire comes from inside of the ELCB and labeled as TL1 & TL2). Replacement model P/N specify "T".

Ex: EG33AC/20-30MA-TL → EW32AAG-3P020B T

Discontinued Accessories for above circuit breakers.

	Discontinued models	Replacement	
Operating Handles (V type)	G-3A / G-5A / G-12A / G-22A / G-42	- (Need to replace with new breaker)	
	G-21A / G-22A / G-41A / G-81A		
	BZ-G10B		
	BZ-V20C / BZ-V20C-E		
	BZ6V10C		
	BZ6V10CP		BZ6V10D
	BZ-V20B-3-Z		OEM item - Contact original machine maker
	BZ-V30C / BZ-V30C-E		- (Need to replace with new breaker)
	BZ-V30C-S / BZ-V30C-ES / BZ-V30C-EUL		- (Need to replace with new breaker)
	BZ-V40B-Z		OEM item - Contact original machine maker
	BZ-V40C / BZ-V40C-E		- (Need to replace with new breaker)
	BZ-V40C-S / BZ-V40C-ES / BZ-V40C-EUL		- (Need to replace with new breaker)
	BZ-V60B-Z		OEM item - Contact original machine maker
	BZ-V70C-E	- (Need to replace with new breaker)	
Operating Handles (N type)	N-3A / N-6A / N-13A / N-21A / N-23A	- (Need to replace with new breaker)	
	N-41A / N-120A		
	BZ-N20C		
	BZ6N10C		
	BZ6N10CP		BZ6V10D
	BZ-N30C		- (Need to replace with new breaker)
	BZ-N30C-****		OEM item - Contact original machine maker
	BZ-N40B		- (Need to replace with new breaker)
	BZ-N40B-****		OEM item - Contact original machine maker
	BZ-N40C		- (Need to replace with new breaker)
	BZ-N60B / BZ-N60C		
	BZ-N70C		
	Handle Lock Covers	BZ-L30C	
BZ-L40C			
Mechanical Interlock	BZ-M130C-2		
	BZ-S60B-225*		
	BZ-E30C-100*		

--: No replacement

Discontinued Products Cross Charts

Discontinued date : March 1989 ~ December 2010

Series		Frame size		Molded Case Circuit Breakers		Earth Leakage Circuit Breakers		
				Discontinued Models	Replacement - UL489 (Non-UL)	Discontinued Models*1	Replacement - UL489 (Non-UL)	
S series	Non-UL	225AF	3 poles	SA203A / SA203B / SA203BA	BW250JAGU-3P	SGa203A(D) / SG203B(D)	EW250JAGU-3P	
				SA203C		SG203C(D)		
				SA203H / SA203R / SA203RA	BW250RAGU-3P	SG203H(D) / SG203R(D)	EW250RAGU-3P	
				SA203RC		SG203RC(D)		
				SA203BN / SA203BAN / SA203CN	-	SG203BA(D)	EW250JAGU-3P	
				SA203RN / SA203RAN / SA203RCN	-	SG203RA(D)	EW250RAGU-3P	
		SA203K	BW250EAGU-3P	-	-			
		4 poles	-	-	SGa204A(D)	(EW250JAG-4P)		
			SA204H / SA204R	(BW250RAG-4P)	SG204H(D)	(EW250RAG-4P)		
			400AF	2 poles	SA402K / SA402B / SA402C	BW400SAGU-2P	-	-
					SA402H / SA402R / SA402RC	BW400RAGU-2P	-	-
					SA402BN / SA402CN	(BW400SAA-2P)		
	SA402RN / SA402RCN				(BW400RAA-2P)			
	3 poles	SA403K / SA403B / SA403C	BW400SAGU-3P	SGa403A(D) / SG403B(D)	EW400SAGU-3P			
		SA403H / SA403R / SA403RC	BW400RAGU-3P	SG403H(D) / SG403R(D)	EW400RAGU-3P			
		SA403BN / SA403CN	(BW400SAA-3P)					
		SA403RN / SA403RCN	(BW400RAA-3P)					
		SA403L	BW400HAGU-3P					
		SA404H / SA404HA	(BW400RAG-4P)	SGa404A(D)	(EW400RAG-4P)			
	600AF	3 poles	SA603 / SA603H / SA603R	BW630RAGU-3P	SG603H(D) / SG603R(D)	EW630RAGU-3P		
			SA603RC		SG603RC(D)			
			SA603RN / SA603RCN	(BW630RAA-3P)	-	-		
			SA603L	BW630HAGU-3P	-	-		
		4 poles	SA604H	(BW630RAG-4P)	-	-		
800AF			3 poles	SA803H / SA803R / SA803RC	BW800RAGU-3P	SG803H(D) / SG803R(D)	(EW800RAG-3P)	
	SA803RC			SG803RC(D)				
	SA803RN	(BW800RAA-3P)		-	-			
	SA803L	BW800HAGU-3P		-	-			
	4 poles	SA804H	(BW800RAG-4P)	-	-			
		UL508	30AF	2 poles	SA32BUL / SA32C	BW50RAGU-2P	-	-
3 poles	SA33BUL / SA33C			BW50RAGU-3P	SG33C	EW50RAGU-3P		
50AF	2 poles			SA52BUL / SA52RUL	BW50RAGU-2P	-	-	
	SA52C / SA52RC			-	-			
	3 poles		SA53BUL / SA53RUL	BW50RAGU-3P	-	-		
			SA53C / SA53RC		SG53C / SG53RC	EW50RAGU-3P		
60AF	2 poles		SA62BUL / SA62RUL	BW100EAGU-2P	-	-		
			SA62C / SA62RC		-	-		
	3 poles		SA63BUL / SA63RUL	BW100EAGU-3P	-	-		
			SA63C / SA63RC		SG63C / SG63RC	EW100EAGU-3P		
UL489	50AF		2 poles	SA52RCUL	BW50RAGU-2P	-	-	
			3 poles	SA53RCUL	BW50RAGU-3P	SG53RCUL	EW50RAGU-3P	
	100AF	2 poles	SA102BAUL / SA102CUL	BW125JAGU-2P	-	-		
			SA102RAUL / SA102RCUL	BW125RAGU-2P	-	-		
		3 poles	SA103BAUL / SA103CUL	BW125JAGU-3P	SG103BAUL / SG103CUL	EW125JAGU-3P		
			SA103RAUL / SA103RCUL	BW125RAGU-3P	-	-		
	225AF	2 poles	SA202BAUL / SA202CUL	BW250JAGU-2P	-	-		
			SA202RAUL / SA202RCUL	BW250RAGU-2P	-	-		
		3 poles	SA203BAUL / SA203CUL	BW250JAGU-3P	SG203BAUL / SG203CUL	EW250JAGU-3P		
			SA203RAUL / SA203RCUL	BW250RAGU-3P	-	-		
	400AF	2 poles	SA402BUL / SA402CUL	BW400SAGU-2P	-	-		
		3 poles	SA403BUL / SA403CUL	BW400SAGU-3P	SG403CUL	EW400SAGU-3P		
		2 poles	SA402RUL / SA402RCUL	BW400RAGU-2P	-	-		
		3 poles	SA403RUL / SA403RCUL	BW400RAGU-3P	-	-		
		600AF	3 poles	SA603RUL / SA603RCUL	BW630RAGU-3P	-	-	
		800AF	3 poles	SA803RUL / SA803RCUL	BW800RAGU-3P	-	-	

Note: All accessories discontinued as well.

- : No replacement

*1: Discontinued Non-UL ELCB has a Trip Lead type, specify "TL" for P/N (Two lead wire comes from inside of the ELCB and labeled as TL1 & TL2). Replacement model P/N specify "T".

Ex: EG33AC/20-30MA-TL → EW32AAG-3P020B T

Discontinued Products Cross Charts

Discontinued date: March 1989 ~ October 2011

Series	Frame size		Molded Case Circuit Breakers		Reference	
			Discontinued Models	Replacement - UL489 (Non-UL)		
BU series UL489 240VAC	100AF	2 poles	BU-ECA2 / BU2ECC (5-50A)	BW50RAGU-2P		
			(60-100A)	BW100EAGU-2P		
		BU-ECA2	-			
		3 poles	BU-ECA3 / BU3ECC (5-50A)	BW50RAGU-3P		
	(60-100)		BW100EAGU-3P			
	225AF	2 poles	BU-GCA2□□□L	BW250EAGU-2P□□□SB		
			BU-GDA2□□□L			
		3 poles	BU-GCA3□□□L	BW250EAGU-3P□□□SB		
			BU-GDA3□□□L			
	400AF	2 poles	BU-KDA2□□□L	BW400EAGU-2P□□□SB		
3 poles		BU-KDA3□□□L	BW400EAGU-3P□□□SB			
UL489 480VAC	100AF	2 poles	BU-ESA2	BW125RAGU-2P		
		3 poles	BU-ESA3	BW125JAGU-3P		
	150AF	2 poles	BU-FSA2	BW125JAGU-2P		
			BU-FSA2150	BW250JAGU-2P150		
			BU-FHA2	BW125RAGU-2P		
			BU-FHA2150	BW250RAGU-2P150		
		3 poles	BU-FSA3	BW125RAGU-3P		
			BU-FSA3150	BW250JAGU-3P150		
	250AF	2 poles	BU-JSA2 / BU-JHA2	-		
		3 poles	BU-JSA3 / BU-JHA3	-		
	400AF	2 poles	BU-KSA2 / BU-KHA2	-		
		3 poles	BU-KSA3 / BU-KHA3	-		
	600AF	2 poles	BU-LSA2 / BU-LHA2 / BU-LHA2T	-		
		3 poles	BU-LSA3 / BU-LHA3 / BU-LHA3T	-		
	800AF	2 poles	BU-MSA2 / BU-MHA2 / BU-MHA2T	-		
		3 poles	BU-MSA3 / BU-MHA3 / BU-MHA3T	-		
	1200AF	2 poles	BU-NSA2 / BU-NHA2 / BU-NHA2T	-		
		3 poles	BU-NSA3 / BU-NHA3 / BU-NHA3T	-		
	UL489 600VAC	100AF	2 poles	BU-ESB2 / BU2EHC	-	(up to 480VAC BW125RAGU-2P)
			3 poles	BU-ESB3 / BU3EHC	-	(up to 480VAC BW125RAGU-3P)
150AF		2 poles	BU-FSB2	-	(up to 480VAC BW125RAGU-2P)	
			BU-FSB2150	-	(up to 480VAC BW250JAGU-2P150)	
			BU-FHB2 / BU2FHC	-	(up to 480VAC BW125RAGU-2P)	
			BU-FHB2150	-	(up to 480VAC BW250RAGU-2P150)	
		3 poles	BU-FSB3	-	(up to 480VAC BW125RAGU-3P)	
			BU-FSB3150	-	(up to 480VAC BW250JAGU-3P150)	
250AF		2 poles	BU-FHB3 / BU3FHC	-	(up to 480VAC BW125RAGU-3P)	
		3 poles	BU-FHB3150	-	(up to 480VAC BW250RAGU-3P150)	
400AF		2 poles	BU-JSB2 / BU-JHB2 / BU2GHC / BU2JHC	-		
		3 poles	BU-JSB3 / BU-JHB3 / BU3GHC / BU3JHC	-		
600AF		2 poles	BU-KSB2 / BU-KHB2 / BU2KHC	-		
		3 poles	BU-KSB3 / BU-KHB3 / BU3KHC	-		
800AF		2 poles	BU-LSB2 / BU-LHB2 / BU-LHB2T / BU2LHC	-		
		3 poles	BU-LSB3 / BU-LHB3 / BU-LHB3T / BU3LHC	-		
1200AF		2 poles	BU-MSB2 / BU-MHB2 / BU-MHB2T / BU2MHC	-		
		3 poles	BU-MSB3 / BU-MHB3 / BU-MHB3T / BU3MHC	-		
1200AF		2 poles	BU-NSB2 / BU-NHB2 / BU-NHB2T / BU2NHC	-		
		3 poles	BU-NSB3 / BU-NHB3 / BU-NHB3T / BU3NHC	-		

Discontinued Accessories for above circuit breakers.

	Discontinued Models	Replacement
Operating Handles (G type / V type / N type)	BU-GEC / BU0VFH / BU0NFH	-
	BU-GGD / BU0VGH / BU0NGH	-
	BU-GKH / BU0VJH / BU0NJH	-
	BU-GLH / BU0VLH / BU0NLH	-
	BU-GNH / BU0VNH / BU0NNH	-

Note: All accessories discontinued as well.
- : No replacement

MEMO:

Terms and Conditions of Sale

Prices

All prices are subject to change without notice. In the event of a price change, the effective date of the change will be the date on the new price or discount schedule sheet.

All quotations made or orders accepted after the effective date will be based on the new prices.

Quotations

Written quotations are valid for 30 days from its date unless otherwise stated in the quotation. Verbal quotations expire the same day they are made.

Taxes

The price does not include any taxes. Buyer shall be responsible for the payment of all applicable taxes.

Terms of payment

Terms of payment will be listed on the quotations.

Minimum orders

Terms of minimum order will be shown on quotations, or if orders amounting to less than the latest minimum order amount, a handling fee will be applied.

Delivery

Delivery of products shall be FOB point of origin in the U.S. Seller shall determine the point of origin of shipment. All shipping and other charges shall be paid by Buyer.

Packing

Prices include standard domestic packing. Additional special packing costs required for export or by Buyer's request will be charged to Buyer.

Weight and Dimensions

The weight and dimensions of products described in this catalog are the best information available at the time of going to press. As Seller follows a policy of continuous product improvement, design changes may make this information obsolete. Information in this catalog is subject to change without notice.

Inspection and acceptance of products

Buyer is responsible for evaluating received products or damage for final acceptance. All claims of shortage must be made within thirty (30) days of receipt of products.

Return / Cancellation

No product shall be returned or canceled unless return/order cancel authorization has been secured from Seller. All returns/cancellations must comply with Seller's then current Return / Cancellation policy.

Risk of Loss

Risk of loss or damage to the product shall pass to Buyer at the FOB point.

Catalog Disclaimer

The information contained in this catalog does not constitute an express or implied warranty of quality, any warranty of merchantability or fitness for a particular purpose is hereby disclaimed. Since the Buyer's product information, specific use application, and conditions of use are all outside of Seller's control, it shall be the responsibility of the Buyer to determine the suitability of any of the products mentioned for the Buyer's application.

ONE YEAR LIMITED WARRANTY

The products identified in this catalog shall be sold pursuant to the terms and conditions identified in the Conditions of Sale issued by Fuji Electric with each order confirmation.

Except to the extent otherwise provided for in the Conditions of Sale issued by Fuji Electric, Fuji Electric warrants that the Fuji Electric products identified in this catalog shall be free from significant defects in materials and workmanship provided the products have not been: (1) repaired or altered by others than Fuji Electric; (2) subjected to negligence, accident, misuse, or damage by circumstances beyond Fuji Electric's control; (3) improperly operated, maintained or stored; or (4) used in other than normal use or service. This warranty shall apply only to defects appearing within one (1) year from the date of shipment by Fuji Electric, and in such case, only if such defects are reported to Fuji Electric within thirty (30) days of discovery by purchaser.

Such notice should be submitted in writing to Fuji Electric Corp. of America. The sole and exclusive remedy with respect to the above warranty whether such claim is based on warranty, contract, negligence, strict liability or any other theory, is limited to the repair or replacement of such

product or, at Fuji Electric's option, reimbursement by Fuji Electric of the purchase price paid to Fuji Electric for the particular product.

FUJI ELECTRIC DOES NOT MAKE ANY OTHER REPRESENTATIONS OR WARRANTIES, WHETHER ORAL OR IN WRITING, EXPRESSED OR IMPLIED, INCLUDING BUT NOT LIMITED TO ANY WARRANTY REGARDING MERCHANTABILITY OR FITNESS FOR A PARTICULAR PURPOSE.

Except as provided in the Conditions of Sale, no agent or representative of Fuji Electric is authorized to modify the terms of this Warranty in writing or orally.

In no event shall Fuji Electric be liable for special, indirect or consequential damages, including but not limited to, loss of use of the product, other equipment, plant, power system, loss of profits or revenues, cost of capital, or claims against the purchaser or user by its customers resulting from the use of information, recommendations and descriptions contained herein. Purchaser agrees to pass on to its customers and users, in writing at the time inquiries and orders are received by buyer, Fuji Electric's warranty as set forth above.

Your Local Authorized Stocking Distributor Is:

Fuji Electric Corp. of America | www.fujielectric.com/fecoa

Fuji Electric (Japan) | www.fujielectric.co.jp

Information in this catalog is subject to change without notice.
February, 2012