

Mini-Contactor and Thermal Overload Relay

SK Series

Types SK06, SK09 and SK12

We have launched world's smallest magnetic contactor and thermal overload relay.

It is applicable for all application with a low capacity of 2.2kW or less.

Types and ratings
Magnetic Contactors

Frame		06	09	12		
Type	Magnetic contactors	AC type	SK06A	SK09A	SK12A	
		DC type (standard)	SK06G	SK09G	SK12G	
		DC type (low consumption)	SK06L	SK09L	SK12L	
Ratings	Max. motor capacity [kW] AC-3	200-240V	1.5kW	2.2kW	3kW	
		380-440V	2.2kW	4kW	5.5kW	
		500-550V	3kW	4kW	5.5kW	
	IEC 60947-4-1	600-690V	3kW	4kW	4kW	
		Optional current Ie [A] AC-3	200-240V	6A	9A	12A
			380-440V	6A	9A	12A
			500-550V	5A	7A	9A
600-690V	3.5A		5A	5A		
Conventional free air thermal current (rated thermal current) Ith [A]		20A	20A	20A		

Thermal Overload Relay

Type	TK12	
Protective function	Overload and phase-loss protection	
Operating characteristics	Trip class 10 A	
Heater element ratings	0.1-0.15A [P10]	1.4-2.1A [1P4]
	0.13-0.2A [P13]	1.7-2.6A [1P7]
* Heat element codes in square brackets [].	0.18-0.27A [P18]	2.2-3.4A [2P2]
	0.24-0.36A [P24]	2.8-4.2A [2P8]
	0.34-0.52A [P34]	4-6A [004]
	0.48-0.72A [P48]	5-7.5A [005]
	0.64-0.96A [P64]	6-9A [006]
	0.8-1.2A [P80]	7-10.5A [007]
	0.95-1.45A [P95]	9-13A [009]

Mini-Contactor and Thermal Overload Relay SK Series SK06, SK09, and SK12

Smallest magnetic contactor in the world, our Keystone to fulfill various customer's requirement.

Magnetic contactor

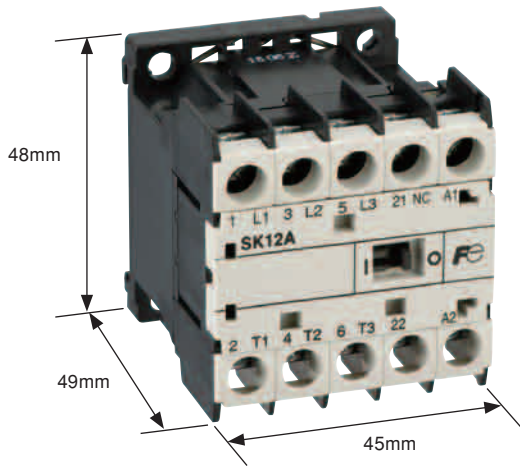

World's smallest mini-contactor

- We have managed to produce AC and DC contactors with the same dimensions of 45 × 48 × 49 mm (width × height × depth).

Wide line-up

- Three ratings of 6A, 9A and 12A are provided.
- We provide controlled coils for the AC, DC and low-consumed type products.





Enhancement of safety and usefulness

- detachable terminal cover is provided as standard (IP20).
- Has a mirror contact function.
- Short-circuit current rating (SCCR): 50 kA, 480 V
*When used in combination with MMS
- UL rating 480 V, 5 HP
- IEC rating 480 V, 12 A (AC-3)

The world's major standards acquired for standard products

- We acquired the IEC, GB (CCC), UL, and TÜV, as well as JIS for our standard products.

Standards

Products	Type	Conformed standards			Certification acquired standards			EC Directive	Certification organization
		IEC	EN	JIS	UL	CSA	GB	CE Marking	TÜV
		International	Europe	Japan	USA	Canada	China	Europe	Germany
			EN	JIS					
Magnetic contactors	SK□A	◎	◎	◎	◎	◎	◎ (1)	◎	◎
	SK□G	◎	◎	◎	◎	◎	◎ (1)	◎	◎
	SK□L	◎	◎	◎	◎	◎	◎ (1)	◎	◎
Thermal overload relay	TK12	◎	◎	◎	◎	◎	◎	◎	◎

(Note) Application: ◎ (conformance with standard products)
(1) Approval pending

Low power consumption

- The controlled coil uses a newly designed electromagnet portion, contributing to power saving in both AC and DC products.

[DC coils]
Standard type DC coil: 2.4 W
Low power consumed DC coil: 1.2 W
* For additional auxiliary contacts, up to two poles can be added.
Direct drive can be achieved with transistor output such as PLC.

Conventional ratio 86%

Comparison with our SJ series products

[AC coils]
Coil (magnet) power consumption

Upon inrush: 22 VA When sealed: 4.5 VA

Conventional ratio 69% **Conventional ratio 75%**

Comparison with SC-M series products

Versatile options

- Additional auxiliary contact units (2-pole, 4-pole)
- Coil-surge suppression unit
- Interlock unit
- Connecting module (use of MMS combination)

Additional auxiliary contact unit (4-pole)

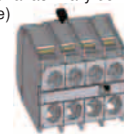

Additional auxiliary contact unit (2-pole)

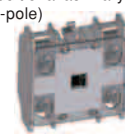

Coil-surge suppression unit



Interlock unit



Thermal Overload Relay



Enhancement of safety

- The standard is a 2E thermal overload relay provided with protection against overload and phase-loss.

Compactness

- A significant compactness has been achieved in combination with the magnetic contactor.

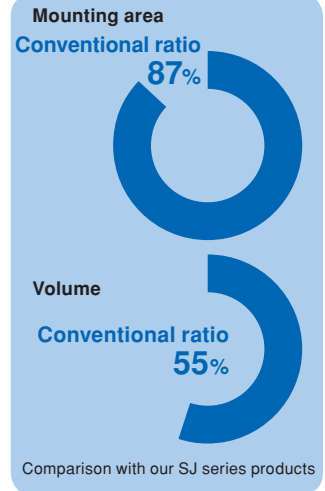
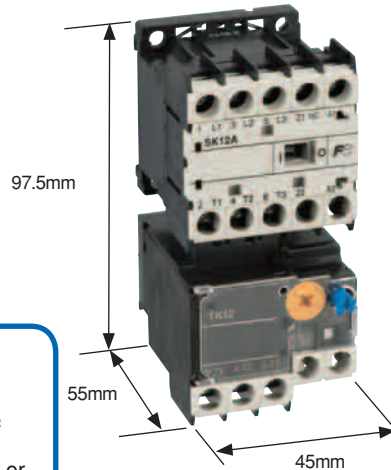

Easier wiring

- ① Round solderless terminals can be connected
- ② Wires can be routed from the secondary side of magnetic contactor
- ③ Terminals are arrayed so that the wires of the main circuit or the auxiliary circuits do not interfere with each other during wiring.

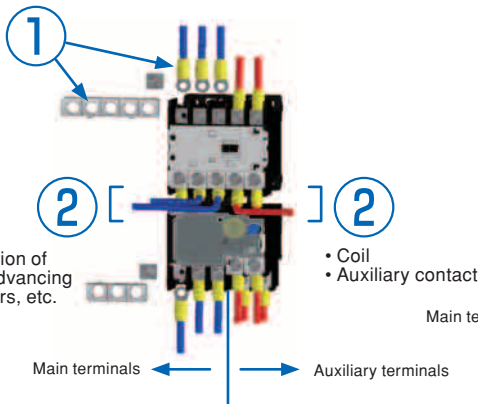

Type TK12

The difficult wiring that was caused by the conventional terminal array was improved.

Conventional product

A screwdriver had to be tilted to avoid interfering with the wires of the auxiliary circuit, which sometimes made it difficult to wire the main circuit.

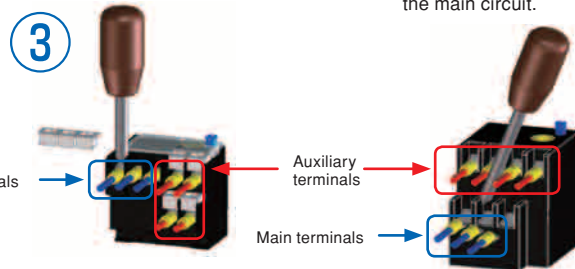

■ Dimensions, mm

● Magnetic contactor

- SK06
- SK09
- SK12

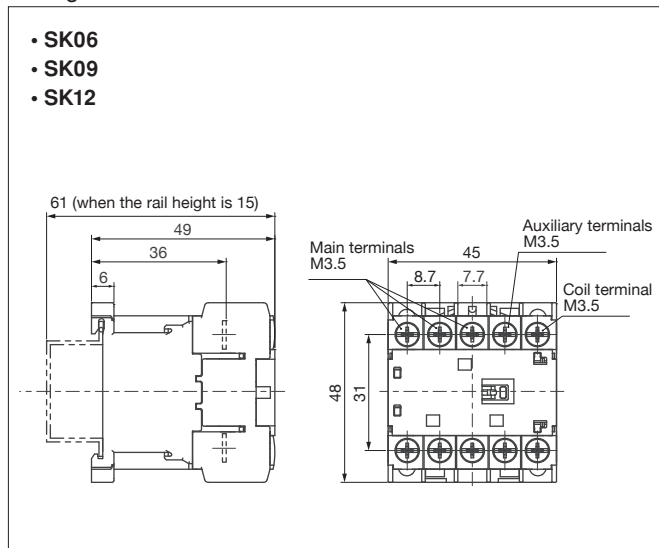

● Thermal Overload Relay

- TK12

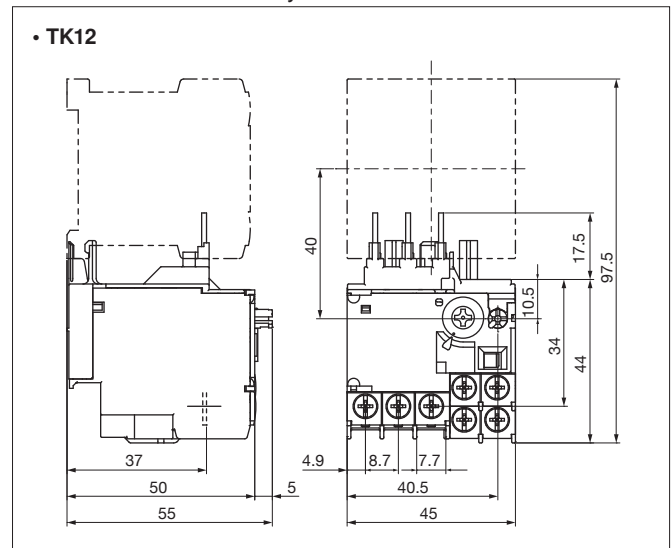

Mini-Contactor and Thermal Overload Relay

SK Series SK06, SK09, and SK12



■ Products

Product	Type	Frame size			
		06	09	12	
Magnetic contactors	AC type	SK□A	○	○	○
	DC type (standard)	SK□G	○	○	○
	DC type (low consumption)	SK□L	○	○	○
Reversing-type magnetic contactors	AC type	SK□AR	○	○	○
	DC type (standard)	SK□GR	○	○	○
	DC type (low consumption)	SK□LR	○	○	○

■ To customers who use the following existing products

Replacing your existing product with SK series products will provide you with many advantages.

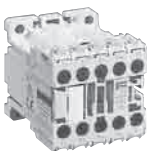
Please take this opportunity of the launch of the new series to consider replacing your existing products.

Series	Existing product	Type of SK series to be replaced	Advantage of replacement
SC-M series 	SC-M01	SK06A	<ul style="list-style-type: none"> • Can be combined with a thermal overload relay. • The dimensions of the AC and DC coil products are the same.
	SC-M01/G	SK06G	
	SC-M01/G1	SK06L	
	SC-M01/G2	SK06L	
	SC-M02	SK09A	
	SC-M02/G	SK09G	
	SC-M02/G1	SK09L	
	SC-M02/G2	SK09L	
SJ series 	SJ-0G	SK06/SK12L (1)	<ul style="list-style-type: none"> • No base is necessary for combining with a thermal overload relay. • Can be used with 400 V circuits for North America. • Auxiliary contacts can be added by customers. • For magnetic starters, the volume ratio is 55%.
	SJ-0WG/X	SK06/SK12LW□K (1)	
	SJ-0WG/N	SK06/SK12LW□K (1)	
	SJ-0WG/2E	SK06/SK12LW□K (1)	
	SJ-06G	SK06/SK12L + SZ1FA11 (1) (2)	
	SJ-06WG	SK06/SK12LW□K + SZ1FA11 (1) (2)	
	SJ-06WG/N	SK06/SK12LW□K + SZ1FA11 (1) (2)	
	SJ-06WG/2E	SK06/SK12LW□K + SZ1FA11 (1) (2)	
S series 	SRC3631-02/X	SK12A	<ul style="list-style-type: none"> • No base is necessary for combining with a thermal overload relay. • Auxiliary contacts can be added. • A coil surge suppression unit comes as an option. • A finger protection terminal cover is equipped as standard.
	SRCa3931-02/X CN	SK12AW	
	SRC3938-06M/X	SK12AR	
	SRCa3938-06RM/X CN	SK12AWR	

(1) The replacement type differs depending on the main circuit voltage.

- Main circuit AC 200 V: SK12
- Main circuit AC 400 V: SK06

(2) "SZ1FA11" shows a type of additional auxiliary contact unit.

⚠ Safety Considerations

- Operate (keep) in the environment specified in the operating instructions and manual. High temperature, high humidity, condensation, dust, corrosive gases, oil, organic solvents, excessive vibration or shock might cause electric shock, fire, erratic operation or failure.
- For safe operation, before using the product read the instruction manual or user manual that comes with the product carefully or consult the Fuji sales representative from which you purchased the product.
- Products introduced in this catalog have not been designed or manufactured for such applications in a system or equipment that will affect human bodies or lives.
- Customers, who want to use the products introduced in this catalog for special systems or devices such as for atomic-energy control, aerospace use, medical use, passenger vehicle, and traffic control, are requested to consult with Fuji Electric FA.
- Customers are requested to prepare safety measures when they apply the products introduced in this catalog to such systems or facilities that will affect human lives or cause severe damage to property if the products become faulty.
- For safe operation, wiring should be conducted only by qualified engineers who have sufficient technical knowledge about electrical work or wiring.
- Follow the regulations of industrial wastes when the product is to be discarded.
- For further questions, please contact your Fuji sales representative or Fuji Electric FA.

Fuji Electric FA Components & Systems Co., Ltd.

5-7, Nihonbashi Odemma-cho, Chuo-ku, Tokyo, 103-0011, Japan

URL <http://www.fujielectric.co.jp/fcs/eng>