

EE-SPW321/421

CSM_EE-SPW321_421_DS_E_5_1

Compact, Thin-profile Photomicrosensor with special amplifier.

- Slim amplifier (50 × 7.5 × 12 mm) can be handled like a cable.
- Provided with two operation indicators, enabling monitoring from the amplifier housing and sensor head.
- Simple wiring with a 3-conductor cable.
- Wide operating voltage range: 12 to 24 VDC



Be sure to read *Safety Precautions* on page 4.

Ordering Information

Sensing method	Sensing distance	Output type	Output configuration	Cable length	Cable length from emitter to amplifier	Model
Through-beam type	300 mm	NPN output	Dark-ON	2 m	0.5 m	EE-SPW321
			Light-ON		1 m	EE-SPW321-A
					0.5 m	EE-SPW421
			1 m		EE-SPW421-A	

Ratings and Specifications

Item	Models	EE-SPW321, EE-SPW421	EE-SPW321-A, EE-SPW421-A
Sensing distance		300 mm *1	
Sensing object		Opaque: 2 mm dia. min. *2	
Directional angle		10° to 40°	
Light source		GaAs infrared LED (pulse lighting) with a peak wavelength of 940 nm	
Indicator		Light indicator (Red LEDs, one each on Sensor and Amplifier)	
Supply voltage		12 to 24 VDC ±10%, ripple (p-p): 5% max.	
Current consumption		Average: 30 mA max.	
Control output		NPN open collector, Load power supply voltage: 12 to 24 VDC, Load current: 100 mA max., OFF current: 0.5 mA max. Residual voltage: 1 V max (at a 100-mA load current)	
Response time		1 ms max. for both detection and reset	
Ambient illumination		3,000 lx max. (incandescent light); 10,000 lx max. (sunlight) on the receiver	
Ambient temperature range		-20 to +55°C	
Ambient humidity range		5% to 85%	
Vibration resistance		Destruction: 10 to 55 Hz, 1.5-mm double amplitude for 2 h each in X, Y, and Z directions	
Shock resistance		500 m/s ²	
Degree of protection		IEC IP64	
Connecting method		Pre-wired (standard cable length: 2 m)	
Cable length from emitter (receiver) to amplifier		0.5 m	1 m
Weight (Packaged)		76 g	
Material	Case	ABS resin	
	Lens	Acrylate resin	
Accessories		Slits: 0.5 × 3 mm, 1 × 3 mm, 3 × 0.5 mm, 3 × 1 mm (one each) Sems screws with spring washers and flat washers: Six M2.6 × 12 Instruction Manual	

*1. Refer to [Receiver Output Vs. Sensing Distance Characteristics](#) on the next page.

*2. Detection of objects up to 0.5 mm wide is possible by using slit installation.

Engineering Data (Reference Value)

Receiver Output vs. Distance Characteristics

EE-SPW321/421

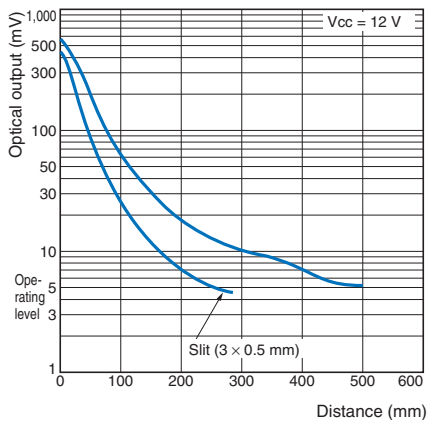

Mutual Interference

EE-SPW321/421

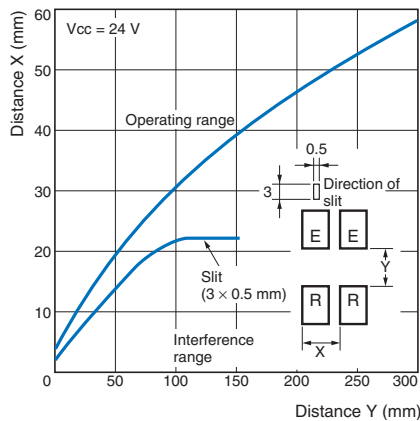

Parallel Movement Characteristics

EE-SPW321/421

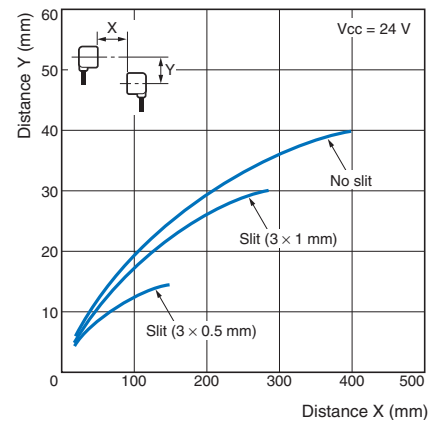

Sensing Angle Characteristics

EE-SPW321/421

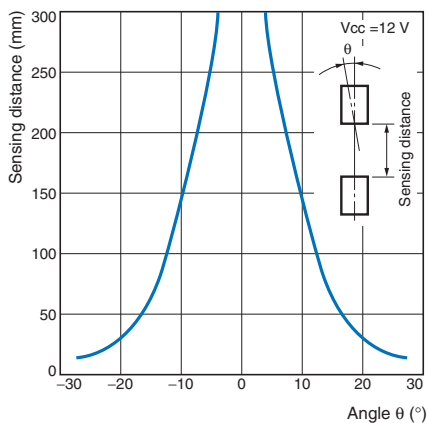

Sensing Distance vs. Input Voltage

EE-SPW321/421

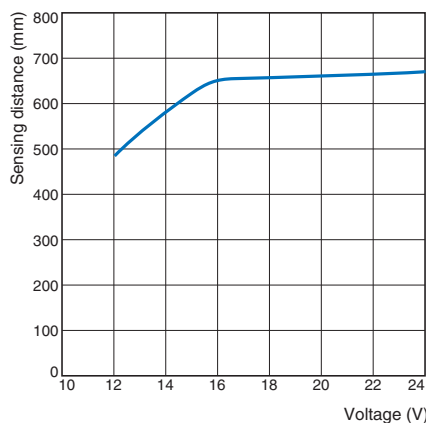

I/O Circuit Diagrams

NPN Output

Model	Output configuration	Timing charts	Output circuit
EE-SPW421(-A)	Light-ON	Incident Interrupted	
EE-SPW321(-A)	Dark-ON	Incident Interrupted	

Sensing Distance with slit installed

Infrared light

Slit type	Sensing distance	Sensing object
None	300 mm	Opaque: 2 mm dia. min.
1 × 3 mm or 3 × 1 mm	200 mm	Opaque: Greater than the slit
0.5 × 3 mm or 3 × 0.5 mm	100 mm	Opaque: Greater than the slit

Safety Precautions

Refer to *Warranty and Limitations of Liability*.

⚠ WARNING

This product is not designed or rated for ensuring safety of persons either directly or indirectly. Do not use it for such purposes.



Precautions for Correct Use

Make sure that this product is used within the rated ambient environment conditions.

● Wiring

Connections

The length of the standard cable is 10 m max. (including the cable attachment, AWG24 min.). When extending the Sensor wires, use a wire greater than AWG 22 in diameter and a cable shorter than 100 m. If the cable length exceeds 10 m, the supply voltage applied at the Sensor terminal will decrease as the impedance of the extended cable increases and the low level output voltage at the cable end will increase. Therefore, take voltage fluctuation into account when extending the Sensor cable.

● Mounting

Tighten the mounting screws to a torque of 0.54 N·m max.

● Adjustment

Aperture Stickers

Two kinds of reticles are attached, the 0.5-mm and the 1.0-mm width types (total of 4 stickers with slit widths A to D as shown in the following diagram).

Use these when the sensing object is 2 mm or smaller or when mutual interference must be reduced.

For each slit of the same type, attach a sticker to the sensing surface of the emitter and receiver.

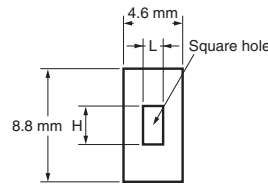

	Size L (mm)	Size H (mm)
Slit A	0.5	3
Slit B	1	3
Slit C	3	0.5
Slit D	3	1

Note: These are pressure sensitive adhesive-type stickers. Peel off the seal and stick it on the lens.

Optical Axis Adjustment

- (1) Set the Sensor so that the center of the lens in the emitter and receiver form one line.
- (2) Having checked that the Sensor is correctly wired, turn ON the power. The operation indicator on the amplifier of the emitter will light. Check to make sure the light goes ON and OFF when an opaque object is moved in and out between the emitter and receiver.
- (3) Move the emitter (or receiver) up and down, left and right and secure the emitter (or receiver) in the center of the range of the operation indicator. Secure the receiver (or emitter) in the same way after adjustment is complete.

(Unit: mm)

Dimensions

Tolerance class IT16 applies to dimensions in this datasheet unless otherwise specified.

EE-SPW321
EE-SPW321-A
EE-SPW421
EE-SPW421-A

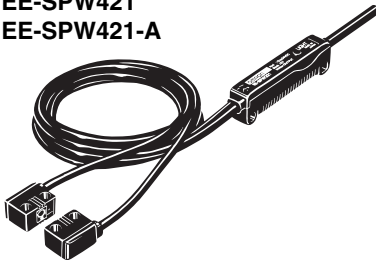

* L = 500 mm (EE-SPW321, EE-SPW421)
L = 1,000 mm (EE-SPW321-A, EE-SPW421-A)

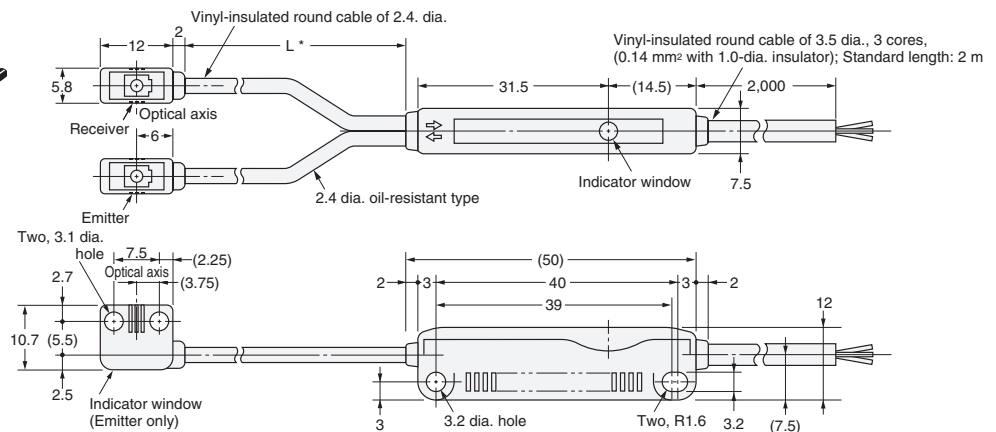

Terms and Conditions Agreement

Read and understand this catalog.

Please read and understand this catalog before purchasing the products. Please consult your OMRON representative if you have any questions or comments.

Warranties.

(a) Exclusive Warranty. Omron's exclusive warranty is that the Products will be free from defects in materials and workmanship for a period of twelve months from the date of sale by Omron (or such other period expressed in writing by Omron). Omron disclaims all other warranties, express or implied.

(b) Limitations. OMRON MAKES NO WARRANTY OR REPRESENTATION, EXPRESS OR IMPLIED, ABOUT NON-INFRINGEMENT, MERCHANTABILITY OR FITNESS FOR A PARTICULAR PURPOSE OF THE PRODUCTS. BUYER ACKNOWLEDGES THAT IT ALONE HAS DETERMINED THAT THE PRODUCTS WILL SUITABLY MEET THE REQUIREMENTS OF THEIR INTENDED USE.

Omron further disclaims all warranties and responsibility of any type for claims or expenses based on infringement by the Products or otherwise of any intellectual property right. (c) Buyer Remedy. Omron's sole obligation hereunder shall be, at Omron's election, to (i) replace (in the form originally shipped with Buyer responsible for labor charges for removal or replacement thereof) the non-complying Product, (ii) repair the non-complying Product, or (iii) repay or credit Buyer an amount equal to the purchase price of the non-complying Product; provided that in no event shall Omron be responsible for warranty, repair, indemnity or any other claims or expenses regarding the Products unless Omron's analysis confirms that the Products were properly handled, stored, installed and maintained and not subject to contamination, abuse, misuse or inappropriate modification. Return of any Products by Buyer must be approved in writing by Omron before shipment. Omron Companies shall not be liable for the suitability or unsuitability or the results from the use of Products in combination with any electrical or electronic components, circuits, system assemblies or any other materials or substances or environments. Any advice, recommendations or information given orally or in writing, are not to be construed as an amendment or addition to the above warranty.

See <http://www.omron.com/global/> or contact your Omron representative for published information.

Limitation on Liability; Etc.

OMRON COMPANIES SHALL NOT BE LIABLE FOR SPECIAL, INDIRECT, INCIDENTAL, OR CONSEQUENTIAL DAMAGES, LOSS OF PROFITS OR PRODUCTION OR COMMERCIAL LOSS IN ANY WAY CONNECTED WITH THE PRODUCTS, WHETHER SUCH CLAIM IS BASED IN CONTRACT, WARRANTY, NEGLIGENCE OR STRICT LIABILITY.

Further, in no event shall liability of Omron Companies exceed the individual price of the Product on which liability is asserted.

Suitability of Use.

Omron Companies shall not be responsible for conformity with any standards, codes or regulations which apply to the combination of the Product in the Buyer's application or use of the Product. At Buyer's request, Omron will provide applicable third party certification documents identifying ratings and limitations of use which apply to the Product. This information by itself is not sufficient for a complete determination of the suitability of the Product in combination with the end product, machine, system, or other application or use. Buyer shall be solely responsible for determining appropriateness of the particular Product with respect to Buyer's application, product or system. Buyer shall take application responsibility in all cases.

NEVER USE THE PRODUCT FOR AN APPLICATION INVOLVING SERIOUS RISK TO LIFE OR PROPERTY OR IN LARGE QUANTITIES WITHOUT ENSURING THAT THE SYSTEM AS A WHOLE HAS BEEN DESIGNED TO ADDRESS THE RISKS, AND THAT THE OMRON PRODUCT(S) IS PROPERLY RATED AND INSTALLED FOR THE INTENDED USE WITHIN THE OVERALL EQUIPMENT OR SYSTEM.

Programmable Products.

Omron Companies shall not be responsible for the user's programming of a programmable Product, or any consequence thereof.

Performance Data.

Data presented in Omron Company websites, catalogs and other materials is provided as a guide for the user in determining suitability and does not constitute a warranty. It may represent the result of Omron's test conditions, and the user must correlate it to actual application requirements. Actual performance is subject to the Omron's Warranty and Limitations of Liability.

Change in Specifications.

Product specifications and accessories may be changed at any time based on improvements and other reasons. It is our practice to change part numbers when published ratings or features are changed, or when significant construction changes are made. However, some specifications of the Product may be changed without any notice. When in doubt, special part numbers may be assigned to fix or establish key specifications for your application. Please consult with your Omron's representative at any time to confirm actual specifications of purchased Product.

Errors and Omissions.

Information presented by Omron Companies has been checked and is believed to be accurate; however, no responsibility is assumed for clerical, typographical or proofreading errors or omissions.